



INTELLIGENT LCD MODULE SPECIFICATIONS



Datasheet Release 2021-08-10
for
CFA634 Series

Hardware Version: v3.2
Firmware Version: v3.3.0 or v3.3.1

Crystalfontz America, Inc.

12412 East Saltese Avenue
Spokane Valley, WA 99216-0357
Phone: 888-206-9720
Fax: 509-892-1203
Email: support@crystalfontz.com
URL: www.crystalfontz.com



/

Table of Contents

1. General Information	5
2. Introduction	6
2.1. Configuration Choices.....	6
2.2. Customize Any Configuration	6
2.3. Part Number Configurations.....	6
2.4. Module Classification Information	7
2.5. Comparison of Color Variants.....	7
2.6. Main Features	8
2.7. Display Mounts.....	8
3. Mechanical Characteristics	9
3.1. Physical Characteristics	9
4. Electrical Specifications	10
4.1. System Block Diagram.....	10
4.2. Absolute Maximum Ratings	10
4.3. LCD Duty and Bias.....	11
4.4. DC Characteristics	11
4.5. Typical Current Consumption	11
5. Optical Characteristics	12
5.1. Optical Characteristics Test Conditions and Definitions	12
5.2. LED Backlight Characteristics.....	12
6. Interface Connection Information	13
6.1. Module Part Numbers (Default Interfaces)	13
6.2. Resetting a Module's Interface to USB	13
6.3. USB Power and Data Communications (CFA634-xxx-KU)	14
6.4. RS232 Power and Data Communications (CFA634-xxx-KS).....	14
6.5. Non-Backlight Operation Through A PC's 9-Pin Serial Port.....	15
6.6. Logic Level (CFA634-xxx-KL) and Logic Level, Inverted (CFA634-xxx-KN).....	16
6.7. SPI (CFA634-xxx-KP)	17
6.8. I ² C (CFA634-xxx-KC).....	19
7. Location and Description of Jumpers to Change Interface Type	20
8. Alternate Method to Power the Backlight for Non-USB Interfaces	22
8.1. To Power the Backlight Using J2 Expansion Port Pins	22
9. Host Communications	23
9.1. About Handshaking.....	23
9.2. Control Codes and Their Functions	23
9.3. Description of Control Functions	24
Cursor Home (\001, 0x01, Control+A)	24
Hide Display (\002, 0x02, Control+B).....	24



/

Show Display (\003, 0x03, Control+C).....	24
Hide Cursor (\004, 0x04, Control+D)	24
Show Underline Cursor (\005, 0x05, Control+E)	24
Show Blinking Block Cursor with Underscore (\006, 0x06, Control+F)	24
Backspace (\008, 0x08, Control+H).....	24
Module Configuration (\009, 0x09, Control+I).....	24
Line Feed (\010, 0x0A, Control+J or Control+Enter)	26
Delete In Place (\011, 0x0B, Control+K)	27
Form Feed (\012, 0x0C, Control+L).....	27
Carriage Return (\013, 0x0D, Control+M).....	27
Backlight Control (\014, 0x0E, Control+N).....	27
Contrast Control (\015, 0x0F, Control+O).....	27
Set Cursor Position (Column and Row) (\017, 0x11, Control+Q)	27
Horizontal Bar Graph (\018, 0x18, Control+R).....	27
Scroll ON (\019, 0x13, Control+S)	28
Scroll OFF (\020, Control+T).....	28
Wrap ON (\023, 0x17, Control+W).....	28
Wrap OFF (\024, 0x18, Control+X).....	28
Set Custom Character Bitmap (\025, 0x19, Control+Y).....	29
Reboot (\026, 0x1A, Control+Z)	30
Escape Sequence Prefix (\027, 0x1B, Escape)	30
Large Block Number (\028, Control Backslash).....	30
Send Data Directly to the LCD Controller (\030, 0x1E, Control+Equal)	31
Show Information Screen (\031, 0x1F, Control+Minus).....	31
10. Character Generator ROM (CGROM)	32
11. LCD Module Reliability and Longevity.....	33
11.1. <i>Module Longevity (EOL / Replacement Policy)</i>	33
12. Care and Handling Precautions.....	34
12.1. <i>ESD (Electrostatic Discharge)</i>	34
12.2. <i>Design and Mounting</i>	34
12.3. <i>Avoid Shock, Impact, Torque, or Tension</i>	34
12.4. <i>If LCD Panel Breaks</i>	34
12.5. <i>Cleaning</i>	34
12.6. <i>Operation</i>	34
12.7. <i>Storage and Recycling</i>	35
13. Mechanical Drawing.....	36
14. Appendix A: Demonstration Software and Sample Code.....	37
14.1. <i>Demonstration Software</i>	37
14.1.1. <i>cfTest</i>	37
14.1.2. <i>CrystalControl2 (CC2)</i>	37
14.1.3. <i>Linux_CLI_Examples</i>	37
14.1.4. <i>BasicStamp2</i>	37
14.1.5. <i>632/634 Boot Screen Beta Version</i>	37
14.2. <i>DRIVERS</i>	37
14.2.1. <i>Linux Driver</i>	37
14.2.2. <i>USB LCD Driver</i>	37



/

Table of Figures

Figure 1. CFA634 Drive Bay Bracket.....	8
Figure 2. System Block Diagram	10
Figure 3. Location of JPDFLT Pins to Reset Interface to USB	13
Figure 4. USB Connector Pins Labeled	14
Figure 5. Non-Backlight Operation Through 9-Pin Serial Port DB9.....	15
Figure 6. Location of J2 7-Pin Expansion Port for LL or LLi Interface	16
Figure 7. Locations of JPWR Expansion Port.....	16
Figure 8. SPI Timing Diagram.....	18
Figure 9. Location of J_I ² C 4-Pin Expansion Port for I ² C Interface	19
Figure 10. Jumper Locations on Back of the PCB	20
Figure 11. Character Generator ROM (CGROM)	32
Figure 12. Mechanical Drawing	36



/

1. General Information

Datasheet Revision History

Datasheet Version: **2021-08-10**
Hardware Version: v3.2
Firmware Version: v3.3.0 and v3.3.1

This datasheet is for the CFA634 Series LCD display module.

For information about firmware and hardware revisions, see the [Part Change Notifications \(PCN\)](#), under “News” in our website’s navigation bar.

For reference, previous datasheets may be downloaded by clicking the “Show Previous Versions of Datasheets” in the “Datasheets” section on the product’s web page.

Product Change Notifications

You can check for or subscribe to [Part Change Notices](#) for this display module on our website.

Variations

Slight variations between lots are normal (e.g., contrast, color, or intensity).

Volatility

This display module has volatile memory.

Disclaimer

Certain applications using CrystalFontz America, Inc. products may involve potential risks of death, personal injury, or severe property or environmental damage (“Critical Applications”). CRYSTALFONTZ AMERICA, INC. PRODUCTS ARE NOT DESIGNED, INTENDED, AUTHORIZED, OR WARRANTED TO BE SUITABLE FOR USE IN LIFE-SUPPORT APPLICATIONS, DEVICES OR SYSTEMS OR OTHER CRITICAL APPLICATIONS. Inclusion of CrystalFontz America, Inc. products in such applications is understood to be fully at the risk of the customer. In order to minimize risks associated with customer applications, adequate design and operating safeguards should be provided by the customer to minimize inherent or procedural hazard. Please contact us if you have any questions concerning potential risk applications.

CrystalFontz America, Inc. assumes no liability for applications assistance, customer product design, software performance, or infringements of patents or services described herein. Nor does CrystalFontz America, Inc. warrant or represent that any license, either express or implied, is granted under any patent right, copyright, or other intellectual property right of CrystalFontz America, Inc. covering or relating to any combination, machine, or process in which our products or services might be or are used.

All specifications in datasheets on our website are, to the best of our knowledge, accurate but not guaranteed. Corrections to specifications are made as any inaccuracies are discovered.

Company and product names mentioned in this publication are trademarks or registered trademarks of their respective owners.

Copyright © 2021 by CrystalFontz America, Inc., 12412 East Saltese Avenue, Spokane Valley, WA 99216 U.S.A.







/

2. Introduction

2.1. Configuration Choices

You can purchase a CFA634 module shipped with any of the six interfaces listed in the table below. The 24-part numbers represent the different combinations of interfaces and colors.

		Part Numbers			
Color Variant		 TFH	 TMI	 YDI	 YFH
Interface	USB 19200 Baud Equivalent Throughout	CFA634-TFH-KU	CFA634-TMI-KU	CFA634-YDI-KU	CFA634-YFH-KU
	RS232 "Full Swing" RS232 Serial (19200 default)	CFA634-TFH-KS	CFA634-TMI-KS	CFA634-YDI-KS	CFA634-YFH-KS
	LL Logic Level Serial (0v to +5v)	CFA634-TFH-KL	CFA634-TMI-KL	CFA634-YDI-KL	CFA634-YFH-KL
	LLi Logic Level Serial, Inverted (+5v to 0v)	CFA634-TFH-KN	CFA634-TMI-KN	CFA634-YDI-KN	CFA634-YFH-KN
	I ² C	CFA634-TFH-KC	CFA634-TMI-KC	CFA634-YDI-KC	CFA634-YFH-KC
	SPI	CFA634-TFH-KP	CFA634-TMI-KP	CFA634-YDI-KP	CFA634-YFH-KP





2.2. Customize Any Configuration

The above configurations can be further customized to include different connectors and cables by selecting the "Customize and Add to Cart" feature on a CFA634 product's web page.

NOTE: A custom part number will be created depending on how you choose to configure the CFA634. For example, the CFA634-YDI-KL part number will change to CFA634-YDI-KL16 if you choose to customize it by adding a 7-pin header.

2.3. Part Number Configurations

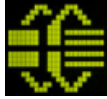
This datasheet uses the following part number naming conventions:

Four Colors, x = Any Interface			
			
CFA634-TFH-Kx	CFA634-TMI-Kx	CFA634-YDI-Kx	CFA634-YFH-Kx

xxx = Any Color Variant	
CFA634-xxx-KC	I ² C
CFA634-xxx-KL	Logic Level Serial
CFA634-xxx-KN	Logic Level Serial, Inverted
CFA634-xxx-KP	SPI
CFA634-xxx-KS	"Full Swing" RS232 Serial
CFA634-xxx-KU	USB







2.4. Module Classification Information

CFA
634
-
*
*
*
-
K
*
*

1
2
3
4
5
6
7
8

1	Brand	CrystalFontz America, Inc.
2	Model Identifier	634
3	Backlight Type & Color	T – LED, white Y – LED, yellow-green
4	Fluid Type, Image (positive or negative), and LCD Glass Color	D – FFSTN, negative, black F – FSTN, positive, neutral M – STN, negative, blue
5	Polarizer Film Type, Temperature Range, and Viewing Angle (o'clock)	I – Transmissive, Wide Temperature Range, 6:00 H – Transflective, Wide Temperature Range, 6:00
6	Special Code	K – Manufacturer's code
7	Interface	C – I2C P – SPI L – LL (Logic Level Serial) N – LLi (Logic Level Serial, Inverted) S – "Full Swing" RS232 Serial U – USB
8	Customization	* = 1 or more characters

2.5. Comparison of Color Variants

Part Number	Fluid	LCD Glass Color	Image	Polarizer Film	LED Backlight
 CFA634-TFH-Kx	STN	neutral	positive	transflective	white
 CFA634-TMI-Kx	STN	blue	negative	transmissive	white
 CFA634-YDI-Kx	FFSTN	black	negative	transmissive	yellow-green
 CFA634-YFH-Kx	FSTN	neutral	positive	transflective	yellow-green



2.6. Main Features

- Large, easy-to-read, 20-character x 4-lines LCD in an overall compact size.
- Attractive stainless-steel bezel.
- May be installed in a standard half-height 5 1/4 drive bay by using our optional drive bay mounting bracket.
- The CFA634 series has four color variant choices:
 - CFA634-TFH-Kx: White edge-lit LED backlight with positive STN transfective mode. Displays dark (near-black) characters on light (near-white) background. The display can be read in normal office lighting, in dark areas, and in bright sunlight.
 - CFA634-TMI-Kx: White edge-lit LED backlight with negative STN transmissive mode LCD. Displays light (near-white) characters on a blue background. The display can be read in normal office lighting and in dark areas. May be difficult to read in direct sunlight.
 - CFA634-YDI-Kx: Yellow-green array LED backlight with negative FFSTN transmissive mode LCD. Displays yellow-green characters on a dark (near-black) background. The display can be read in normal office lighting and in dark areas. May be difficult to read in direct sunlight.
 - CFA634-YFH-Kx: Yellow-green array LED backlight with positive FSTN transfective mode LCD. Displays dark (near-black) characters on yellow-green background. The display can be read in normal office lighting, in dark areas, and in bright sunlight.
- Six interface configurations, please see [Interface Connection Information](#).
- The display has a wide viewing angle with a 6 o'clock viewing direction.
- Temperature range for operation is -20°C to + 70°C.
- Adjustable contrast. The default contrast value for the module will be acceptable for most applications. If necessary, adjust the contrast using control function [Contrast Control \(015, 0x0F, Control+O\)](#).
- The display has a RockWorks RW1067 or compatible controller.
- Robust packet-based protocol with 16-bit CRC ensures error-free communications.
- Extended voltage (9V-15V for interfaces using DB9 connector), 5V power inputs for the controller, 5V for the backlight.
- Nonvolatile memory capability (EEPROM) to customize the “power-on” display settings.
- CrystalFontz America, Inc. is ISO 9001:2008 certified.
- A Declaration for Conformity for REACH and RoHS, are available on each display’s web page.

2.7. Display Mounts

On the web page for the [CFA634 Series](#), after you click the “Customize and Add to Cart” button, you will see a list of options for different cables, connectors, and drive bay bracket.



Figure 1. CFA634 Drive Bay Bracket

NOTE: If you want a CFA634-xxx-KC, CFA634-xxx-KL, or CFA634-xxx-KP module mounted on a bracket with an overlay, please contact our Technical Support team at support@crystalfontz.com to receive a price quote.

See [Interface Connection Information](#) for descriptions of suggested cables for the various interfaces. Additional cables are available for purchase on our [website](#).



/

3. Mechanical Characteristics

3.1. Physical Characteristics

Item	Specification (mm)	Specification (inch, reference)
Overall Width and Height	130.0 (W) x 63.0 (H)	5.118 (W) x 2.480 (H)
Module Depth (includes DB9 connector)	19.90 (D)	0.783 (D)
Active Area	93.54 (W) x 34.0 (H)	3.683 (W) x 1.339 (H)
Viewing Area	102.0 (W) x 41.5 (H)	4.016 (W) x 1.634 (H)
Character Pitch	4.68 (W) x 8.90 (H)	0.184 (W) x 0.350 (H)
Character Size	3.84 (W) x 7.30 (H)	0.151 (W) x 0.287 (H)
Pixel Size	0.72 (W) x 0.86 (H)	0.028 (W) x 0.034 (H)
Pixel Pitch	0.78 (W) x 0.92 (H)	0.031 (W) x 0.036 (H)
Weight (typical)	119 grams	4.20 ounces



/

4. Electrical Specifications

4.1. System Block Diagram

The CFA634 offers six interface choices. Use any of the six interfaces by changing the interface selection in a command and using the appropriate jumper configurations. Please see [Interface Connection Information](#) and [Module Configuration \(009, 0x09, Control+I\)](#).

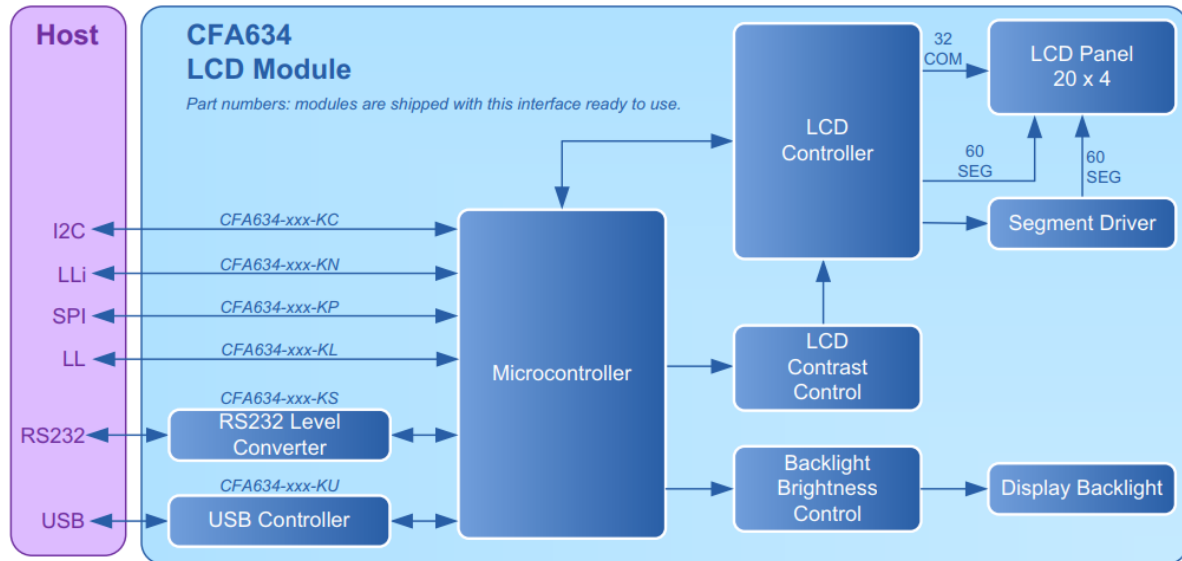

Figure 2. System Block Diagram

4.2. Absolute Maximum Ratings

Absolute Maximum Ratings	Symbol	Minimum	Maximum
Operating Temperature	T_{OP}	-20°C	+70°C
Storage Temperature	T_{ST}	-30°C	+80°C
Humidity Range (Non-condensing)	RH	10%	90%
Supply Voltage for Logic	V_{DD}	0v	+5.25v
Input and Output Pins for RS232 Serial (CFA634-xxx-KS)			
RS232 Input Pin	V_{RX}	-25v	+25v
RS232 Output Pin	V_{TX}	-13v	+13v
<p>Please note that these are stress ratings only. Extended exposure to the absolute maximum ratings listed above may affect device reliability or cause permanent damage. Functional operation of the module at these conditions beyond those listed under DC Characteristics is not implied. Changes in temperature can result in changes in contrast.</p> <p>Powering from pins 4 and 7 on DB9, maximum voltage rating is +15v (see pin descriptions).</p>			



4.3. LCD Duty and Bias

Driving Method	Specification
Duty	1/32
Bias	1/6.7

4.4. DC Characteristics

DC Characteristics	Symbol	Minimum	Typical	Maximum
Supply Voltage for Logic (+5v)	$V_{DD}-V_O$	+4.8v	+5.0v	+5.25v
Logic Input High Voltage	V_{IH}	+2.1v	-	V_{DD}
GPIO Input Low Voltage	V_{IL}	V_{SS}	-	+0.08v
RS232 serial (for CFA634-xxx-KS) supplied through DB9 connector using on-board regulator		±9v	-	±15v

4.5. Typical Current Consumption

Current consumption is the same for all interfaces; although it does differ by color variant.

CFA634-TFH-Kx

Items Enabled		Typical Current Consumption	
Logic	LCD Backlights	$V_{DD}= +4.5v$	$V_{DD}= +5.0v$
X	0%	32 mA	34 mA
X	100%	119 mA	145 mA

CFA634-TMI-Kx

Items Enabled		Typical Current Consumption	
Logic	LCD Backlights	$V_{DD}= +4.5v$	$V_{DD}= +5.0v$
X	0%	32 mA	34 mA
X	100%	120 mA	146 mA

CFA634-YDI-Kx

Items Enabled		Typical Current Consumption	
Logic	LCD Backlights	$V_{DD}= +4.5v$	$V_{DD}= +5.0v$
X	0%	27 mA	29 mA
X	100%	293 mA	492 mA

CFA634-YFH-Kx

Items Enabled		Typical Current Consumption	
Logic	LCD Backlights	$V_{DD}= +4.5v$	$V_{DD}= +5.0v$
X	0%	32 mA	37 mA
X	100%	309 mA	508 mA



/

5. Optical Characteristics

CFA634-TFH-Kx, CFA634-YDI-Kx, and CFA634-YFH-Kx					
Item	Symbol	Condition	Typical	Unit	
Viewing Angle	Horizontal	θ_{x+}	60	Degree	
		θ_{x-}	30		
	Vertical	θ_{y+}	40		
		θ_{y-}	40		
Contrast Ratio		CR	—	4	-
Response Time	T rise	$T_a=25^{\circ}\text{C}$	150	ms	
	T fall		120	ms	
Viewing Direction: 6 o'clock					

CFA634-TMI-Kx					
Item	Symbol	Condition	Typical	Unit	
Viewing Angle	Horizontal	θ_{x+}	40	Degree	
		θ_{x-}	35		
	Vertical	θ_{y+}	30		
		θ_{y-}	30		
Contrast Ratio		CR	—	4	-
Response Time	T rise	$T_a=25^{\circ}\text{C}$	150	ms	
	T fall		120	ms	
Viewing Direction: 6 o'clock					

5.1. Optical Characteristics Test Conditions and Definitions

We work to continuously improve our products, including backlights that are brighter and last longer. Please note that slight color variations from module-to-module and batch-to-batch are normal.

- Viewing Angle
 - Vertical (V) θ : 0°
 - Horizontal (H) ϕ : 0°
- Frame Frequency: 78 Hz
- Driving Waveform: 1/16 Duty, 1/13 Bias
- Ambient Temperature (T_a): 25°C

5.2. LED Backlight Characteristics

Test Condition: Supply Voltage = V_{DD}

Item	Symbol	Typical
Luminance		
CFA634-TFH-Kx	L_v	200 cd/m^2
CFA634-TMI-Kx		400 cd/m^2
CFA634-YDI-Kx		70 cd/m^2
CFA634-YFH-Kx		65 cd/m^2
Backlight PWM Frequency	-	300 Hz (nominal)
NOTE: Negative modules are measured in an area of the display where all of the pixels are on. Positive modules are measured in an area of the display where all of the pixels are off.		



/

6. Interface Connection Information

6.1. Module Part Numbers (Default Interfaces)

CFA634 part numbers are shipped with the following default interfaces.

Part Number	Default Interface
CFA634-xxx-KC	I ² C
CFA634-xxx-KL	Logic Level Serial
CFA634-xxx-KN	Logic Level Serial, Inverted
CFA634-xxx-KP	SPI
CFA634-xxx-KS	“Full Swing” RS232 Serial
CFA634-xxx-KU	USB

NOTE: The hardware is identical no matter which interface is selected.

To change the default interface for any of these display modules:

1. Change the interface selection setting using the control function [Module Configuration \(\009, 0x09, Control+1\)](#).
2. Ensure the jumpers are in the correct position; please see [Location and Description of Jumpers to Change Interface Type](#).
3. Use the connection information below.

6.2. Resetting a Module’s Interface to USB

Any display module can be reset to the USB interface at 19200 kbps. Temporarily jump (short) the two JPDFLT pins together while the display module is powered. The module will display the reset screen. Cycle the power to reset the module to USB.

Short JPDFLT pins to reset interface to USB.

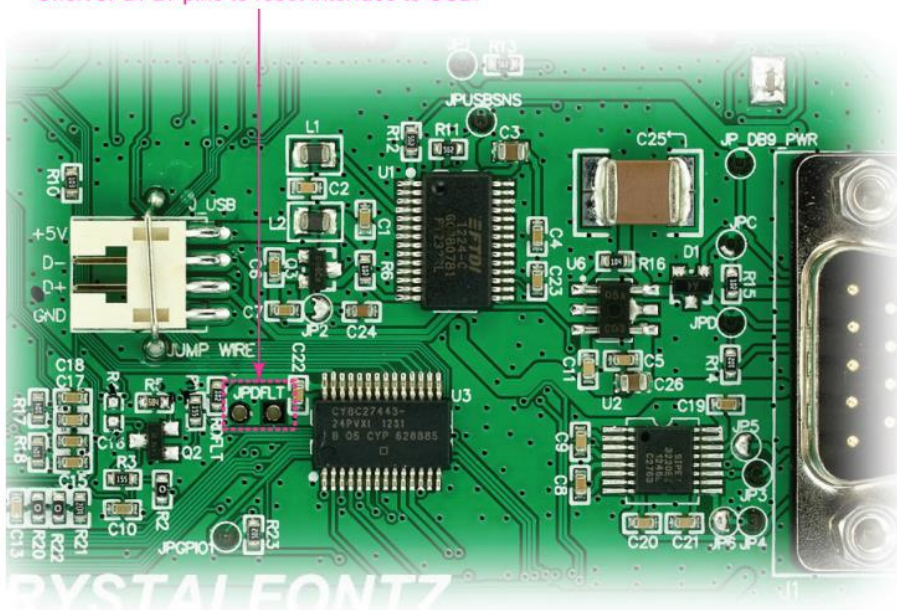

Figure 3. Location of JPDFLT Pins to Reset Interface to USB



6.3. USB Power and Data Communications (CFA634-xxx-KU)

The USB interface requires only one connection to the host for both data communications and power supply. The module has a low profile 2mm latching polarized connector for USB connection.

We offer three USB cables to connect between the display module and the host:

1. Use the [WR-USB-Y03](#) (~1.94 meters) to connect the cable's smaller 2mm female USB connector to the display module's 2mm male USB connector. Connect the cable's larger USB-A female connector to host's USB-A connector.
2. Use the [WR-USB-Y11](#) (~0.77 meters) to connect the cable's 2mm female USB connector to the display module's 2mm male USB connector. Connect the four single-pin connectors directly onto the USB headers (typically found on motherboards).
3. Use the [WR-USB-Y33](#) (~0.69 meters) to connect the cable's smaller 2mm female USB connector to the display module's 2mm male USB connector. Connect the cable's larger female 4-pin 0.1" connector to the USB pins on the host's motherboard.

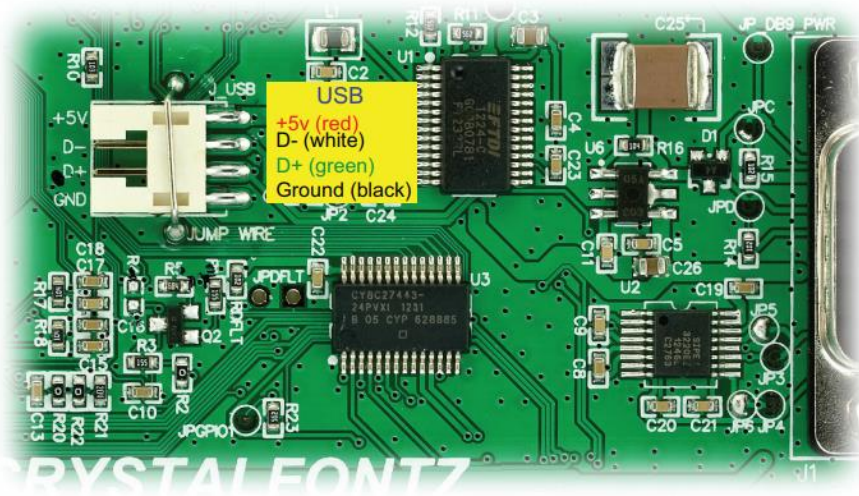

Figure 4. USB Connector Pins Labeled

6.4. RS232 Power and Data Communications (CFA634-xxx-KS)

The CFA634 has a male 9-pin DB9 connector that can connect to a PC's 9-pin serial port. Below is a view looking into the male DB9 connector (labeled J1):



Pin	Part Number	Default Interface
1	Not Connected	DCD (Data Carrier Detect)
2	Not Connected	Rx (Receive Data)
3	Data In	Tx (Transmit Data)
4	Power A (9-volts to 15-volts)	DTR (Data Terminal Ready)
5	Ground (VSS)	Signal Ground
6	Connected to Power A if JPD is Closed	DSR (Data Set Ready)
7	Power B (9-volts to 15-volts)	RTS (Request to Send)
8	Connected to Power B if JPC is Closed	CTS (Clear to Send)
9	Not Connected	RI (Ring Indicator)



Most RS232 ports will be able to power the display module but will not be able to power the backlight through the DTR and RTS lines. Drive these lines high (most software already will). Beginning with hardware v3.0, the module includes the ability to support, and change between, multiple interfaces. With this ability came an increase in current consumption resulting in a greater need from the host device. To power the backlight in RS232 mode, refer to the alternate method for powering the backlight below.

6.5. Non-Backlight Operation Through A PC's 9-Pin Serial Port

For non-backlight operation when the module is connected to a PC's 9-pin serial port, use a "straight through" RS232 9-pin female-to-female DB9 cable. Connect one of the cable's RS232 female DB9 connectors to the DB9 male connector on the display module. Connect the cable's other RS232 female DB9 connector to the DB9 male connector on the PC.

These DB9 cables lengths are available on our [website](#):

- [WR-232-Y01](#) ~1.765m
- [WR-232-Y04](#) ~2.95m
- [WR-232-Y10](#) ~0.315m

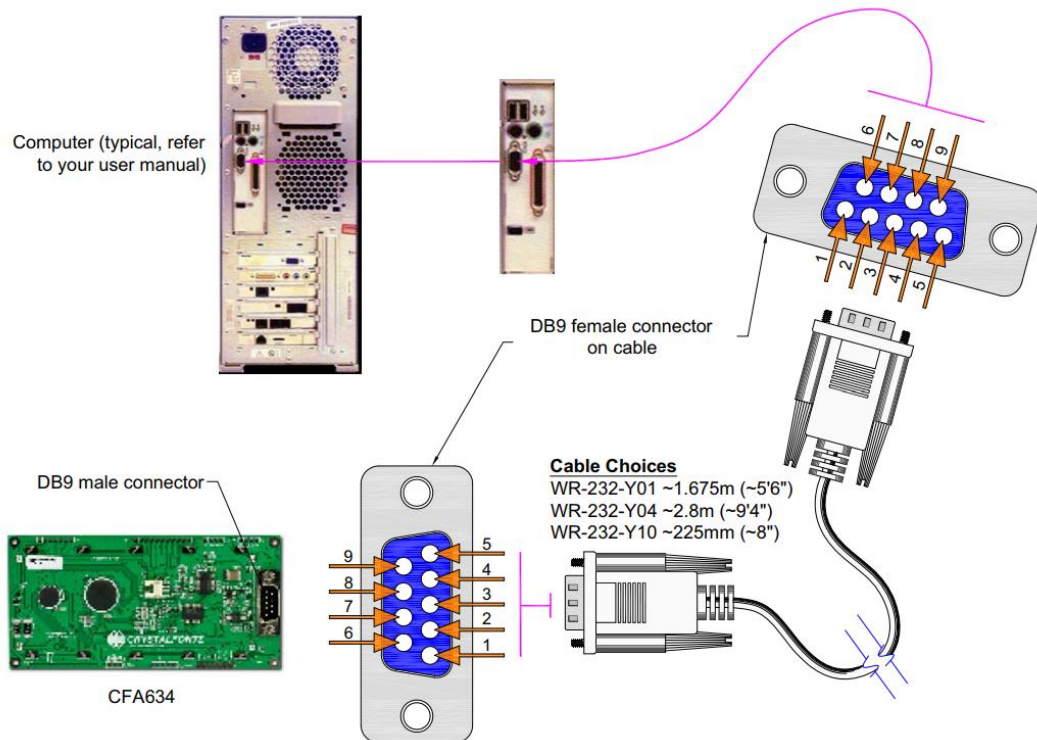

Figure 5. Non-Backlight Operation Through 9-Pin Serial Port DB9

- To connect the display module with RS232 interface to a PC expansion slot, use a [WR-232-Y09](#) ribbon cable (~0.965 meters).
- To connect a display module with RS232 to a motherboard with a 10-pin male connector with normal or alternate pinout, use a [WR-232-Y23](#) (~0.655 meters) cable.
- The DB9 pin serial RS232 plus DC power connector the serial connectivity and power to be brought out another device. A DB9 serial connection does not use all of its 9-pins in the interface with an RS232 cable. The [WR-232-Y18](#) cable (~2.8 meters) was designed to piggy-back a power supply so that the unused pins now provide 5V power.



6.6. Logic Level (CFA634-xxx-KL) and Logic Level, Inverted (CFA634-xxx-KN)

Logic Level (LL) or Logic Level, inverted (LLi) are useful when the display module is used with an embedded microcontroller’s built-in UART. These UARTs typically output an inverted logic level (0-5V) version of the RS232 waveform. By setting the display module to accept LL or LLi data, this logic level signal can be connected directly to the display module and avoid the RS232 driver requirement.

To connect the display module to most embedded systems, use the display module’s expansion port J2. The J2 expansion port has standard 0.1-inch (2.54mm) spacing. Generally, a regulated 5v supply for the controller would be connected to +5V(LCD), GROUND to GROUND, and module’s output to MOSI. MOSI will only accept 0v to 3.3v “CMOS” or 0v to 5v logic levels. If the data is inverted, which is a common configuration of a microcontroller “UART Tx” pin, configure the display module to use the LL or LLi interface.

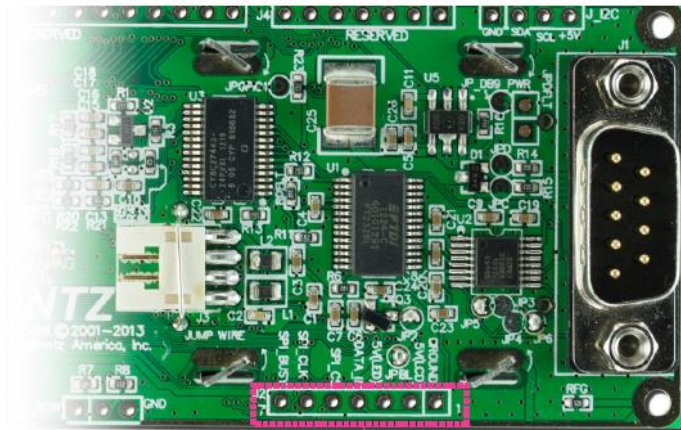

J2 7-Pin Expansion Port For LL Or LLi Interface

Figure 6. Location of J2 7-Pin Expansion Port for LL or LLi Interface

NOTE: A possible J2 connector for LL or LLi communications is the [Digi-Key 7-Pin Molex 22-23-2071](#).

To Power the Display Module Using J2 or JPWR Expansion Port Pins

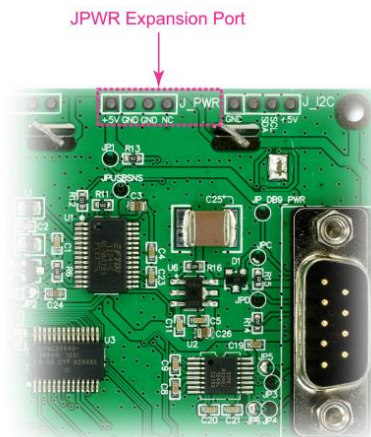

Figure 7. Locations of JPWR Expansion Port



The easiest place in a PC to get +5V is from a disk drive power connector. The red wire is typically 5-volts and the black wires are typically ground. The [WR-PWR-Y02](#) cable (~0.935 meters) or the [WR-PWR-Y12](#) cable (~320mm) will connect from a spare power connector from a PC's power supply to the display module.

NOTE: If you make your own cable, be sure to measure the output voltage and polarity before you connect the display module – some computers may have unconventional wire color assignments. A possible connector for the JPWR expansion port is the 4-pin [Digi-Key Molex 22-23-2041](#).

IMPORTANT: Do not use the yellow wire of the disk drive power cable. This wire is typically a 12V supply and will ruin the display module and/or backlight if it is connected. A 5V supply is recommended to power the backlight.

6.7. SPI (CFA634-xxx-KP)

SPI up to 8 MHz is useful with embedded microprocessors that lack a hardware UART. On the host microprocessor, any three general-purpose output ports and a small “send byte” routine can be used to control the display module. If the host microprocessor has a hardware SPI port, that can be used, provided that the port's speed can be set to satisfy the timing constraints. A software state-machine and a timer interrupt could also be used, this would reduce the microprocessor's load while still satisfying the timing requirements.

Another useful feature of SPI is that additional displays can be controlled with only one additional output port (SPI_CS) per display. The other lines (SPI_CLK and SPI_DATA) are common. When in SPI mode, the module will display “SPI” instead of the baud rate on the information screen. Please see [Show Information Screen \(\031, 0x1F, Control+Minus\)](#).

The module has a 64-character input buffer. For the RS232 interface, it is nearly impossible to overflow this buffer since the module can process commands more quickly than the 115200 baud RS232 interface can deliver them, so normally no flow control is needed. The exceptions are the routines that access the EEPROM (the \009 series) and a rare combination of commands that take a long time to execute, followed by a burst of characters that are larger than the input buffer.

If the processor can deliver data through the SPI interface at a rate faster than 1000 bytes/second, then the processor should make sure the MISO line is “low” before sending a new command. The MISO line will be held “high” by the display module when there are 32 or more characters in the module's input buffer and released when there are fewer than 32 characters.

The SPI interface option allows the module to communicate over the standard 4-wire SPI lines (SCLK, MOSI, MISO, and SS). Its clock is controlled by the master and is therefore able to communicate at any of the multitude of standard SPI data rates. The SPI interface uses Mode 3 communication in the MSB configuration. Multiple slaves can be connected together using the master's slave select.



The CFA634 display module uses Mode 3 in the diagram below:

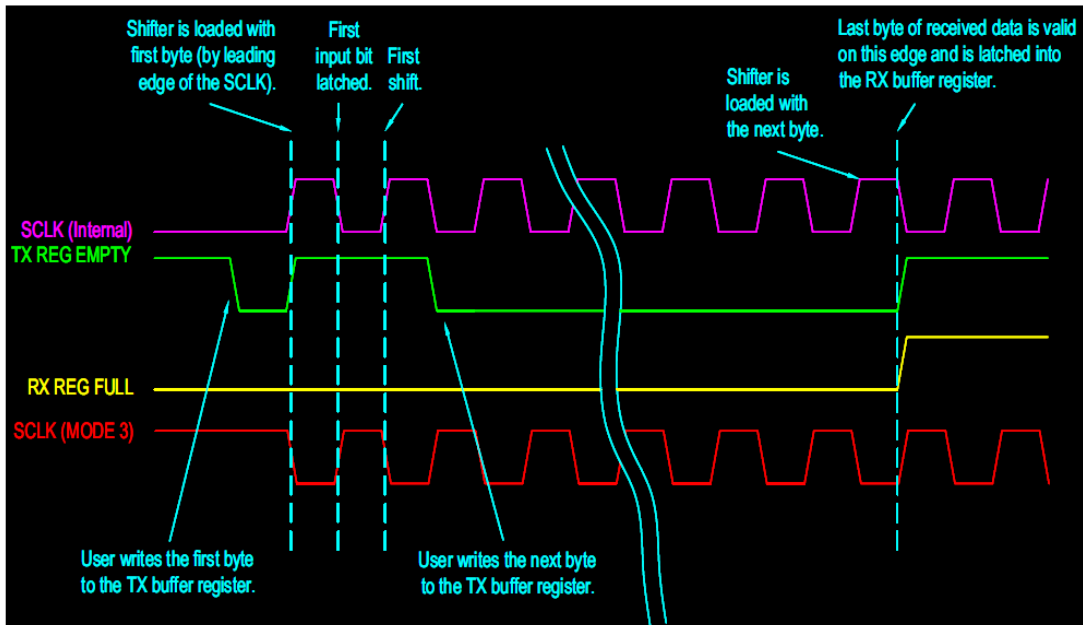

Figure 8. SPI Timing Diagram

- $\overline{SPI_CS}$ must be low before $\overline{SPI_CLK}$ falls.
- $\overline{SPI_CS}$ must stay low for the entire transfer.
- SPI_DATA must be correct before $\overline{SPI_CLK}$ falls.
- SPI_DATA must be held for a minimum of 50 μ s after $\overline{SPI_CLK}$ falls.
- The maximum clock rate is 1/55 μ s or 1/125 ns or 8 MHz.
- Data is transferred MSB first; two out of eight cycles are shown.
- CPOL = 1, CPHA = 1 for most processors.
- Take $\overline{SPI_CS}$ high for a minimum of 55 μ s to guarantee bit synchronization.
- Maximum throughput is $1/(9 \times 55) = 2020$ bytes / seconds.



6.8. I²C (CFA634-xxx-KC)

The I²C interface option allows the module to operate in slave mode supporting the 100-kbps original and 400 kbps fast mode communication speeds. Benefits to using I²C are: only two data/bus lines are required, no strict clocking to confine the environment, and a simple master/slave relationship with multi-device support utilizing a software configurable address. The CFA634-xxx-KC has internal pull-ups of 40k Ω to 80k Ω that may not be sufficient in all circumstances. We recommend including external pull-ups as appropriate to your application.

A possible connector for I²C expansion port is the 4-pin [Digi-Key Molex 22-23-2041](#) loaded at J_I²C. This will also allow the module to be powered using that header, if desired.

The display module ships by default with an I²C address of 42₁₀. The I²C protocol specifies each module with two addresses. The first 7 bits of both addresses are the same, in this case 00101010₂. The address is then left bit-shifted with a read bit (1) or write bit (0). If a master device wishes to write to the module, it would transmit 01010100₂ which is 42₁₀ left bit-shifted with a 0 (84₁₀). If instead a master device wishes to read from the display module, it would transmit 01010101₂ which is 42 left bit-shifted with a 1 (85₁₀).

NOTE: Each command byte and all applicable data bytes must be transmitted as a single “packet” in order to be processed correctly.

In order for I²C to work correctly, JP3, JP4, JP5, and JP6 must all be open. If these jumpers are closed, the RS-232 level chip attempts to drive the I²C lines.

J_I²C Expansion Port For 4-pin I²C connector



Figure 9. Location of J_I²C 4-Pin Expansion Port for I²C Interface



7. Location and Description of Jumpers to Change Interface Type

The module's PCB has twelve jumpers, ten of the twelve jumpers can be changed. See the [Jumpers That Can Be Changed](#) table for details.

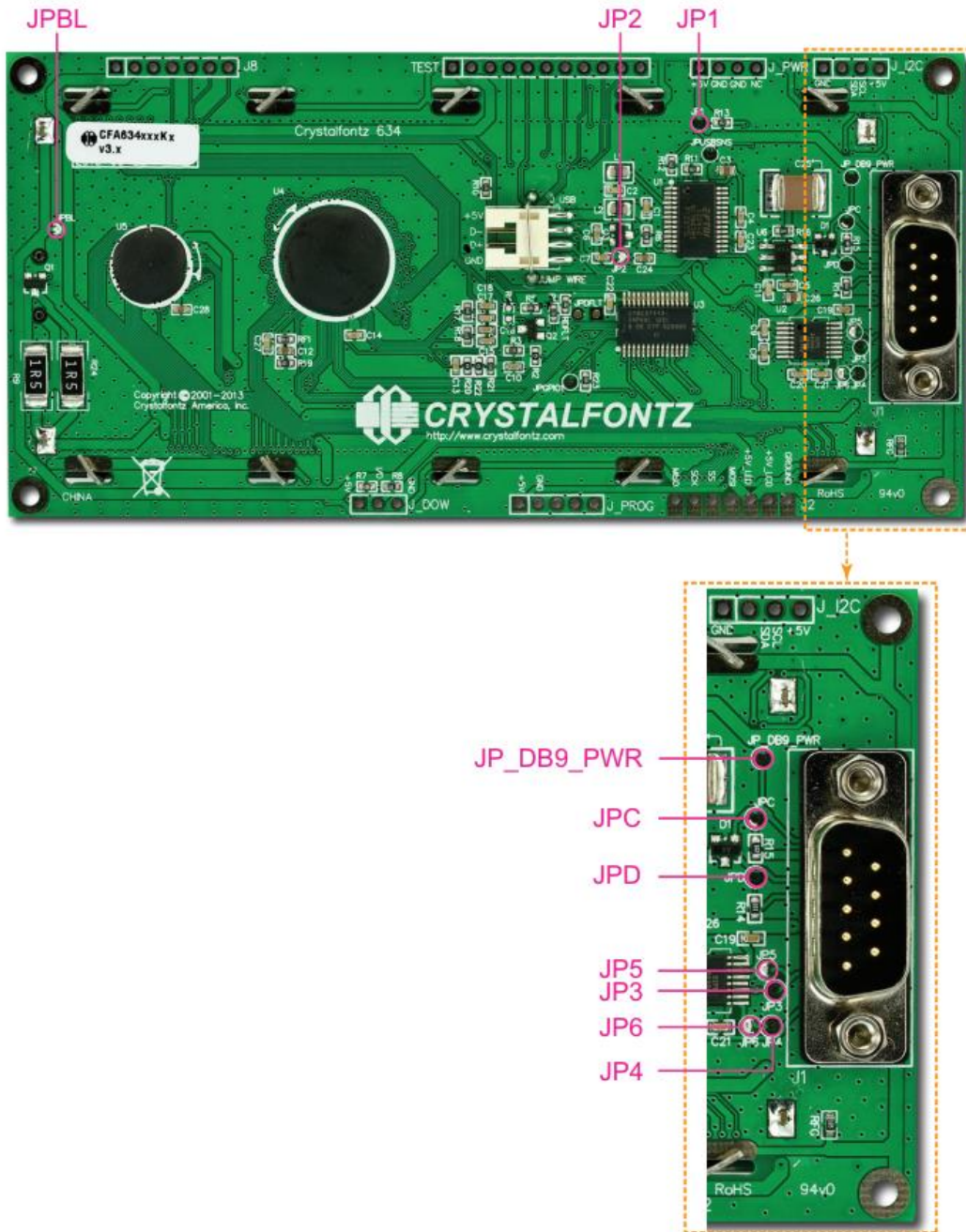

Figure 10. Jumper Locations on Back of the PCB



/

To change the interface type on a module, certain jumpers may need to be opened or closed. To close a jumper, melt solder across the gap; to open a jumper, remove the solder (Solder Wick works well for this).

Do not change factory setting on JPGPIO1 and JPUSBSNS						
Jumpers That Can Be Changed	Specifications	USB	RS232	LL/LLi	I ² C	SPI
JP3, JP4	Open: DATA_IN is RS232 (-10v to +10v swing) Closed: DATA_IN is 0v to +5v swing.	-	Open	Closed	Open	Closed
JP5, JP6	Open: DATA_IN is 0v to +5v swing. Closed: DATA_IN is RS232 (-10v to +10v swing)	-	Closed	Open	Open	Open
JPC, JPD	Some host hardware or software may require the display module to assert its DSR and/or CTS lines before it will send data to the display module. Open: JPC – DSR is open. JPD – CTS is open. Closed: JPC – DTR is fed back on DSR through 1K Ω resistor. JPD – RTS is fed back on CTS through 1K Ω resistor.	-	Open/Closed	-	-	-
JP2	Open: Disconnects USB's +5v power line from display module's +5v power plane. Closed: Connects USB's +5v power line from display module's +5v power plane.	Closed	Open	-	-	-
For All Interfaces						
JPBL	Open: Use separate supply for logic and backlight. Closed: Connects +5v LCD line to display module's +5v power plane to power the backlight from the same supply as the logic.					
JP_DB9_PWR	Open: Disconnects DB9 Pins 7 and 8 from the display module's power plane. Closed: Connects DB9 Pins 7 and/or 8 directly to the display module's +5v power plane. Closing this jumper and connecting the module via the DB9 connector may put voltage in excess of +6v to the module and damage it beyond repair.					
JP1	Open: Disconnects the JPWR header from the display module's +5v power plane. Closed: Connects the JPWR header to the display module's +5v power plane. NOTE: JPWR's +5v pin is always connected to the PSoC.					
JPGPIO1	Reserved					
JPUSBSNS	Reserved					
*Frame ground is a trace connecting the mounting hole, bezel, and shell of the DB9.						



/

8. Alternate Method to Power the Backlight for Non-USB Interfaces

The module's backlight brightness is controlled by Pulse Width Modulation (PWM). The PWM may cause noise on supplies that have high output impedance. Noise from the backlight PWM can cause problems in your application.

Connecting a filter capacitor from +5V(LCD) to GROUND close to the module can alleviate this problem. Alternately, the backlight can be operated at full brightness, which disables the PWM.

Using the backlight in any of the following configurations requires a regulated +5V supply capable of sourcing 400mA, hereby referred to as "the supply". The supply can connect to any +5V(LED) terminal. This may be the same supply that is used for +5V(LCD).

IMPORTANT: Connecting a supply greater than 5.25V to V_{DD} or 5V(LED) will damage the display module.

8.1. To Power the Backlight Using J2 Expansion Port Pins

To power the backlight, connect the supply to pin 3 labeled +5V(LED) on the J2 connector. The supply's ground should be connected to the V_{DD} terminal of J2 labeled GROUND, shown below.



Pin	Pin Name	Function
1	GROUND	Ground (Backlight and Controller)
2	+5V (LCD)	Controller and LCD Power (+5V Only)
3	+5V (LED)	LED Backlight Power (+5V Only)
4	MOSI	Master Out, Slave In Serial Data In (input)
5	SS	SPI Chip Select (Active Low Input)
6	SCK	SPI Clock (Input)
7	MISO	Master In, Slave Out SPI Busy (for status output)



/

9. Host Communications

For RS232 Serial Interface (CFA634-xxx-KS), the baud rate is set in the firmware. In previous versions of this module, the baud rate was set with dip switches. Please see [Interface Selection Choices](#) in the table in [Module Configuration \(\009, 0x09, Control+I\)](#).

9.1. About Handshaking

- The display module can generally execute commands faster than the interface can deliver them so handshaking is not necessary from the module's point of view. The few exceptions involve accessing the EEPROM (for example, see [Module Configuration \(\009, 0x09, Control+I\)](#)).
- For RS232 Serial Interface (CFA634-***-KS), some host hardware or software may require the module to assert its DSR and/or CTS lines before it will send data to the display. In that case, JPC and/or JPD may be closed. Closing JPC will connect DSR to DTR through a 1K Ω resistor. Closing JPD will connect CTS to RTS through a 1K Ω resistor. See [Location and Description of Jumpers to Change Interface Type](#).

9.2. Control Codes and Their Functions

The module will accept plain ASCII characters and display them on the screen at the current cursor position. For example, if "Hello World" is sent, the display shows "Hello World". The module also supports a set of control characters that access other features of the display. Some of these commands require one or more parameters. In general, the parameters are "binary" characters, meaning that any value between 0 and 255 may be required.

The notation "\xxx" is used for "binary" data, where "xxx" is the decimal representation of the number. Use the codes \000 to \255 to include all possible values for a character. This notation is supported by our [cfTest](#) software. We recommend trying this utility by using the examples listed under [Description of Control Functions](#).

Below is a summary of the control codes. Click on the links in the ASCII column to jump to an explanation of the code function.

ASCII	HEX	Keystrokes	Control Code Functions
\000	0x00	-	Not Accessible
\001	0x01	Control+A	Cursor Home
\002	0x02	Control+B	Hide Display
\003	0x03	Control+C	Show Display
\004	0x04	Control+D	Hide Cursor
\005	0x05	Control+E	Show Underline Cursor
\006	0x06	Control+F	Show Blinking Block Cursor with Underscore
\007	0x07	-	Not Accessible
\008	0x08	Control+H	Backspace (Destructive)
\009	0x09	Control+I	Module Configuration
\010	0x0A	Control+J or Control +Enter	Line Feed
\011	0x0B	Control+K	Delete In Place
\012	0x0C	Control+L	Form Feed (Clear Display)
\013	0x0D	Control+M	Carriage Return
\014	0x0E	Control+N	Backlight Control
\015	0x0F	Control+O	Contrast Control
\016	0x10	-	Not Accessible
\017	0x11	Control+Q	Set Cursor Position (Column and Row)



/

ASCII	HEX	Keystrokes	Control Code Functions
\018	0x12	Control+R	Horizontal Bar Graph
\019	0x13	Control+S	Scroll ON
\020	0x14	Control+T	Scroll OFF
\021	0x15	-	Not Accessible
\022	0x16	-	Not Accessible
\023	0x17	Control+W	Wrap ON
\024	0x18	Control+X	Wrap OFF
\025	0x19	Control+Y	Set Custom Character Bitmap
\026	0x1A	Control+Z	Reboot
\027	0x1B	Escape	Escape Sequence Prefix
\028	0x1C	Control+\	Large Block Number
\029	0x1D	-	Not Accessible
\030	0x1E	Control+Equal	Send Data Directly to LCD Controller
\031	0x1F	Control+Minus	Show Information Screen
\028- \135	-	-	Custom Characters 0 through 7

9.3. Description of Control Functions

Cursor Home (\001, 0x01, Control+A)

Moves cursor to the top left character position. No data is changed. Identical to Control+Q,0,0.

Hide Display (\002, 0x02, Control+B)

Display is blanked; no data is changed.

Show Display (\003, 0x03, Control+C)

Restores blanked display; nothing else is changed.

Hide Cursor (\004, 0x04, Control+D)

Cursor is not shown; nothing else is changed.

Show Underline Cursor (\005, 0x05, Control+E)

Sets cursor to nonblinking underscore.

Show Blinking Block Cursor with Underscore (\006, 0x06, Control+F)

Sets cursor to blinking block underscore.

Backspace (\008, 0x08, Control+H)

Moves the cursor back one space and erases the character in that space. Will wrap from the left-most column to the right-most column of the line above. Will wrap from the left-most column of the top row to the right-most column of the bottom row. Ignores wrap.

Module Configuration (\009, 0x09, Control+I)

This command allows the current state of the module to be stored in the display's EEPROM, recalling of the EEPROM contents to the display, and controlling the boot behavior.

All features of the display module are controlled: the characters displayed, the bitmaps of the user-definable characters, the backlight setting, the contrast setting, the cursor position, the cursor style, the wrap setting, the scroll setting, interface selection, baud rate, data normal / inverted, and boot state.



/

NOTE: Since writing and reading the EEPROM takes quite a bit of time, it is possible to overflow the display module's input buffer if data is continuously sent while the display module is busy executing these commands. The display module will still buffer data while these commands are being executed. However, the buffer is 64 bytes long and can be overflowed. Care must be taken not to overflow the input buffer while the EEPROM commands are executing.

Module Configuration Commands	
Display Duration	
\009\000	
\000	Displays Permanently
\001	Displays Until Input
\002	Displays for ~5 seconds, then goes blank

Screen Selection	
\009\001	
\000	CrystalFontz Display
\001	User Display (Custom Boot Screen)

NOTE: When changing any communication settings, the selection takes place immediately. Have proper cables ready to use before changing interfaces.

Reconnection at the new baud rate if using Baud Selection (RS232 only) or the new address if changing Set Slave Address (I²C only) will be necessary.

1. Connect at the current interface and/or baud rate.
2. Send the command to change to the new interface and/or baud rate. If changing the interface, refer to the [Jumpers That Can Be Changed](#) table to ensure jumpers are set appropriately.
3. Reconnect at current interface and/or baud rate.

Module Configuration Commands (Cont.)	
Interface Selection	
\009\002	
\000	USB
\001	"Full Swing" RS232 Serial Interface over DB9
\002	SPI
\003	I ² C
\004	LL (Logic Level Serial)
\005	LLi (Logic Level Serial, inverted)



/

Example: Change Interface

1. Connect using the current interface (USB by default for CFAXXX-xxx-KU, RS232 by default for CFAXXX-xxx-KS, etc.).
2. Send command \009\002\002 (e.g., SPI interface), using cfTest or any other communication software.
3. Disconnect the current interface.
4. Ensure jumpers JP3 and JP4 are closed and jumpers JP5 and JP6 are open. (Please see [Location and Description of Jumpers to Change Interface Type.](#))
5. Connect using the new interface.

Baud Selection (RS232 Only)	
\009\003	
\000	2400 bps
\001	4800 bps
\002	9600 bps
\003	19200 bps
\004	115200 bps

Example: Change Baud Rate (Baud selection is only applicable to RS232)

1. Ensure jumpers JP3 and JP4 are open and jumpers JP5 and JP6 are closed. (Please see [Location and Description of Jumpers to Change Interface Type.](#))
2. Connect using the RS232 interface.
3. Send Command \009\003\002 (9600 bps) using cfTest or any other communication software.
4. Reconnect at the new baud rate.

Set Slave Address (I ² C Only)	
\009\004	
Data[1]	New Address

Save Settings	
\009\005	

Recall Settings	
\009\006	

Line Feed (\010, 0x0A, Control+J or Control+Enter)

Moves the cursor down one row. If SCROLL is on and the cursor is at the bottom row, the display will scroll up one row and the bottom row will be cleared.

IMPORTANT: If SCROLL is set, the cursor is placed on the bottom line, several Line Feed characters are sent (forcing the display to scroll), and these Line Feed characters are immediately followed by a burst of more than 64 additional characters. It is possible to overflow the display module's input buffer, **but do not do this** – the display will not start executing the input buffer data as if it were code. The display will simply overwrite the oldest data in the input buffer with the most recently received data.



/

Delete In Place (\011, 0x0B, Control+K)

Deletes the character at the current cursor position. Cursor is not moved.

Form Feed (\012, 0x0C, Control+L)

Clears the display and returns cursor to Home position (upper left). All data is erased.

Carriage Return (\013, 0x0D, Control+M)

Moves cursor to the left-most column of the current row.

Backlight Control (\014, 0x0E, Control+N)

Send "Control+N", followed by a byte from 0-100 for the backlight brightness. 0=OFF, 100=ON, intermediate values will vary the brightness.

Examples:

```
\014\000
\014\050
\014\100
```

Contrast Control (\015, 0x0F, Control+O)

Send "Control+O", followed by a byte from 0-100 for the contrast setting of the displayed characters.

0 = very light 40 = typical 100 = very dark

Examples:

```
\015\050
\015\060
\015\070
```

Set Cursor Position (Column and Row) (\017, 0x11, Control+Q)

Send "Control+Q" followed by one byte for the column (0-15), and a second byte for the row (0-3). The upper-left position is 0,0. The lower-right position is 15,1.

For example, to move the cursor to column 11 of the second line:

```
\017\010\001
```

Horizontal Bar Graph (\018, 0x18, Control+R)

Send "Control+R" followed by the following bytes:

```
graph_index
style
start_column
end_column
length
row
```

graph_index determines the custom characters that are used.

graph_index	Custom Characters Used
\000	0,1
\001	2,3
\002	4,5
\003	6,7



`style` is the bit pattern to use in drawing the graph.

style	Pattern	Description
<code>\255</code>	<code>(11111111b)</code>	Thick Bar
<code>\000</code>	<code>(00000000b)</code>	Not Visible (All Pixels Are Off)
<code>\085</code>	<code>(01010101b)</code>	Striped Bar
<code>\060</code>	<code>(00111100b)</code>	Medium Width Bar, Centered
<code>\015</code>	<code>(00001111b)</code>	Medium Width Bar, Low in The Row
<code>\240</code>	<code>(11110000b)</code>	Medium Width Bar, High in The Row

Any value is valid between `\000` and `\255`. The Most Significant Bit (MSB) is at the top of the row, the Least Significant Bit (LSB) is at the bottom of the row.

`start_column` and `end_column` are the character X coordinates of the graph area. Each must be between `\000` and `\015`. `start_column` must be less than or equal to `end_column`.

`length` is the length in pixels of the graph. Positive values will graph from the left edge of `start_column`, negative values will graph from the right edge of `end_column`. There are six pixels per character, so the maximum value of `length` is $16 \times 6 = \096$.

`row` is the character Y coordinate. `\000`-`\001` is valid.

Examples:

```
\018\000\255\000\014\010\001
\018\000\015\000\014\236\001
```

NOTE: The entire graph area is completely rewritten by each graph command, so there is no need to clear the area between successive updates of the same graph. If a length of `\000` is written, the entire graph area is cleared to spaces. Negative values can be calculated as $256 - \text{value}$. For instance, if you want a graph to extend 20 pixels towards the left, from the right most column of the graph area, send 236 ($256 - 20 = 236$). No additional graph “setup” command is needed.

IMPORTANT: The graphs use some of the custom characters and may corrupt the display contents if there are user-defined custom characters or large numbers shown.

Scroll ON (`\019, 0x13, Control+S`)

Turns scroll feature on. Then a Line Feed (Control+J) command from the bottom row will scroll the display up by one row, independent of Wrap. If Wrap is also on (Control+W), a wrap occurring on the bottom row will cause the display to scroll up one row. Scroll is on by default.

Scroll OFF (`\020, Control+T`)

Turns scroll feature off. Then a Line Feed (Control+J) command from the bottom row will move the cursor to the top row of the same column, independent of wrap (Control+W for Wrap ON, Control+X for Wrap OFF). If wrap is on, a wrap occurring on the bottom row will also wrap vertically to the top row. Please note that Scroll is on by default at power-up.

Wrap ON (`\023, 0x17, Control+W`)

Turns wrap feature on. When wrap is on, a printable character received when the cursor is at the right-most column will cause the cursor to move down one row to the left-most column. If the cursor is already at the right-most column of the bottom row, it will wrap to the top row if Scroll is off, or the display will scroll up one row if Scroll is on.

Wrap OFF (`\024, 0x18, Control+X`)

Turns wrap feature off. When wrap is off, a printable character received when the cursor is at the right-most column will cause the cursor to disappear as it will be off the right edge of the screen. Any subsequent characters will be ignored until some other command moves the cursor back onto the display. This function is independent of Scroll.



/

Set Custom Character Bitmap (\025, 0x19, Control+Y)

The custom characters are mapped at \128 through \135 corresponding to character 0 to character 7.

Send “Control+Y” followed by the following bytes:

```
character
data0
data1
data2
data3
data4
data5
data6
data7
```

`character` determines which of the eight custom characters is modified; 0-7 are valid. The custom characters are displayed by sending \128 to \135:

character	Custom Character Modified
\128	0
\129	1
\130	2
\131	3
\132	4
\133	5
\134	6
\135	7

`data0–data7` are the bitmap information for this character. Any value is valid between 0 and 63. The MSB is at the left of the character cell of the row and the LSB is at the right of the character cell. `data0` is at the top of the cell, `data7` is at the bottom of the cell.

IMPORTANT: The large digits use all of the custom characters, so if you modify the custom characters when large digits are displayed, *the display module is likely to become corrupted*. The bar graphs also use some of the custom characters.

Examples:

```
\012\001\128\129\130\131\017\000\001\132\133\134\135
\025\000\000\000\001\003\000\031\031\031
\025\001\028\054\032\001\003\051\051\051
\025\002\014\027\049\032\032\047\032\047
\025\003\000\000\032\048\000\062\000\062
\025\004\031\031\031\000\003\001\000\000
\025\005\051\051\051\003\001\032\054\028
\025\006\047\032\047\032\032\049\027\014
\025\007\062\000\062\000\048\032\000\000
```



/

Reboot (\026, 0x1A, Control+Z)

The firmware is stable and robust. It is unlikely the “reboot” command will be needed. If the firmware were to crash, the command processor would likely be inoperable and unable to detect the reboot command. However, there may be certain situations where it is nice to have a command that will return the display module to a known state. For instance, if the baud rate on the host is set to an incorrect speed, the data is interpreted as meaningless information that the display module’s firmware tries to interpret. Some data may set the contrast to an unusable value; some data may program the LCD controller to an indeterminate state. Or perhaps you always want the display module to wake up in a given state when your program starts, without going through all the commands that affect the way the display module interprets commands (e.g., the state of Scroll or Wrap).

Send one “Control+Z” followed by another “Control+Z” to reboot the display module. If the display module’s state is unknown it may be necessary to send up to 9 characters to satisfy the parameters of some previous command. For example, if the Set Custom Character Bitmap command (see [Set Custom Character Bitmap \(\025, 0x19, Control+Y\)](#)) has just been received by the module when an application crashes, the module will interpret the next 9 bytes as the parameters to the command, then wait for more commands. In the case the display module’s state is unknown, send 9 blanks (\032) followed by two “Control+Z”s (\026).

For RS232 serial (CFA634-xxx-KS): If the display module is powered by the serial port’s RTS and DTR lines, the display module can be rebooted by dropping those lines momentarily (for example, 500 mS), and then bringing them high again.

Escape Sequence Prefix (\027, 0x1B, Escape)

Four escape sequences are supported. These correspond to the escape sequences that are sent for the four arrow keys in HyperTerminal with an ANSI terminal selected. These sequences only move the cursor, they do not wrap.

Escape Sequence	Arrow Key
ESC [A (equivalent to \027\091\065)	UP Arrow
ESC [B (equivalent to \027\091\066)	DOWN Arrow
ESC [C (equivalent to \027\091\067)	RIGHT Arrow
ESC [D (equivalent to \027\091\068)	LEFT Arrow

Large Block Number (\028, Control Backslash)

Send “Control+Backslash” followed by the following bytes:

```
style
column
number
```

style determines if a large number (3x4 or 4x4) is displayed.

style	Function
\000	3x4 Large Number
\001	4x4 Large Number
\002	Invalid

column is the starting column of the number.

\000-\017 are valid for a style of \000 (3x4)

\000-\016 are valid for a style of \001 (4x4)



/

`number` is the number to display. \048 to \057 ('0' to '9') are valid.

NOTE: The large numbers use all the custom characters. There will be some corruption if they are used at the same time as graphs or user defined custom characters. No large number initialization command is needed.

Example:

```
\004\012\028\000\0010\028\000\0051\028\000\0092\028\000\0133\028\000\0174
\004\012\028\000\0005\028\000\0046\028\000\0087\028\000\0128\028\000\0169
\004\012\028\001\0000\028\001\0051\028\001\0102\028\001\0153
\004\012\028\001\0006\028\001\0057\028\001\0108\028\001\0159
```

Send Data Directly to the LCD Controller (\030, 0x1E, Control+Equal)

Send "Control+Equal" followed by the following bytes:

`location`
`data`

`location` is the destination register on the LCD controller:

location	Register
\000	Control Register, (RS=0, RE=0)
\001	Data Memory, (RS=1, RE=x)

`data` is the data to write to the controller:

IMPORTANT: This command executes a low-level write directly to the controller. "Control+Z" followed by another "Control+Z" will reboot the display and recover from most mistakes. **Use this command at your own risk – this command can disable or damage the display module.**

Example:

```
\030\002\031\030\002\130
```

Show Information Screen (\031, 0x1F, Control+Minus)

This function will show the baud rate for CFA634-xxx-KL and CFA634-xxx-KS. This function will show the interface mode for CFA634-xxx-KC, CFA634-xxx-KP, and CFA634-xxx-KU.



10. Character Generator ROM (CGROM)

To find the code for a given character, add the two numbers that are shown in bold for its row and column. For example, the superscript "9" is in the column labeled "128d" and in the row labeled "9d". Add 128 + 9 to get 137. When a byte with the value of 137 is sent to the display module, then a superscript "9" will be shown.

upper 4 bits lower 4 bits	0 _d 0000.	16 _d 0001.	32 _d 0010.	48 _d 0011.	64 _d 0100.	80 _d 0101.	96 _d 0110.	112 _d 0111.	128 _d 1000.	144 _d 1001.	160 _d 1010.	176 _d 1011.	192 _d 1100.	208 _d 1101.	224 _d 1110.	240 _d 1111.
0 _d 0000.	CGRAM [0]															
1 _d 0001.	CGRAM [1]															
2 _d 0010.	CGRAM [2]															
3 _d 0011.	CGRAM [3]															
4 _d 0100.	CGRAM [4]															
5 _d 0101.	CGRAM [5]															
6 _d 0110.	CGRAM [6]															
7 _d 0111.	CGRAM [7]															
8 _d 1000.	CGRAM [0]															
9 _d 1001.	CGRAM [1]															
10 _d 1010.	CGRAM [2]															
11 _d 1011.	CGRAM [3]															
12 _d 1100.	CGRAM [4]															
13 _d 1101.	CGRAM [5]															
14 _d 1110.	CGRAM [6]															
15 _d 1111.	CGRAM [7]															

Figure 11. Character Generator ROM (CGROM)



/

11. LCD Module Reliability and Longevity

We work to continuously improve our products, including backlights that are brighter and last longer. Slight color variations from module-to-module and batch-to-batch are normal.

Item	Specification	
Yellow-green LED Backlight	50,000 to 100,000 hours (typical)	
White LED Backlight	Power-On Hours	& of Initial Brightness
	<10,000	>70%
	<50,000	>50%
<p><i>For display modules with white LED backlights (CFA631-TMF-KU and CFA631P-TMF-KU), adjust backlight brightness so the display is readable but not too bright. Dim or turn off the backlight during periods of inactivity to conserve the white LED backlight lifetime.</i></p> <p><i>Under operating and storage temperature specification limitations, humidity non-condensing RH up to 65%, and no exposure to direct sunlight. Value listed above are approximate and represent typical lifetime.</i></p>		

11.1. Module Longevity (EOL / Replacement Policy)

CrystalFontz is committed to making all of our LCD modules available for as long as possible. For each module that we introduce, we intend to offer it indefinitely. We do not preplan a module's obsolescence. The majority of modules we have introduced are still available.

We recognize that discontinuing a module may cause problems for some customers. However, rapidly changing technologies, component availability, or low customer order levels may force us to discontinue ("End of Life", EOL) a module. For example, we must occasionally discontinue a module when a supplier discontinues a component or a manufacturing process becomes obsolete. When we discontinue a module, we will do our best to find an acceptable replacement module with the same fit, form, and function.

In most situations, you will not notice a difference when comparing a "fit, form, and function" replacement module to the discontinued module it replaces. However, sometimes a change in component or process for the replacement module results in a slight variation, perhaps an improvement, over the previous design.

Although the replacement module is still within the stated Datasheet specifications and tolerances of the discontinued module, changes may require modification to your circuit and/or firmware. Possible changes include:

- Backlight LEDs. Brightness may be affected (perhaps the new LEDs have better efficiency) or the current they draw may change (new LEDs may have a different VF).
- Controller. A new controller may require minor changes in your code.
- Component tolerances. Module components have manufacturing tolerances. In extreme cases, the tolerance stack can change the visual or operating characteristics.

Please understand that we avoid changing a module whenever possible; we only discontinue a module if we have no other option. We post Part Change Notices (PCNs) on the product's website page as soon as possible. If interested, you can subscribe to future [Part Change Notices](#).



/

12. Care and Handling Precautions

For optimum operation of the CFA634 and to prolong its life, please follow the precautions described below.

12.1. ESD (Electrostatic Discharge)

The circuitry is industry standard CMOS logic and susceptible to ESD damage. Please use industry standard antistatic precautions as you would for any other static sensitive devices such as expansion cards, motherboards, or integrated circuits. Ground your body, work surfaces, and equipment.

12.2. Design and Mounting

- The exposed surface of the “glass” is actually a polarizer laminated on top of the glass. To protect the soft plastic polarizer from damage, the module ships with a protective film over the polarizer. Please peel off the protective film slowly. Peeling off the protective film abruptly may generate static electricity.
- When handling the module, avoid touching the polarizer. Finger oils are difficult to remove.
- To protect the soft plastic polarizer from damage, place a transparent plate (for example, acrylic, polycarbonate, or glass), in front of the module, leaving a small gap between the plate and the display surface.
- Do not disassemble or modify the module.
- Do not modify the six tabs of the metal bezel or make connections to them.
- Do not reverse polarity to the power supply connections. Reversing polarity will immediately ruin the module.

12.3. Avoid Shock, Impact, Torque, or Tension

- Do not expose the CFA634 to strong mechanical shock, impact, torque, or tension.
- Do not drop, toss, bend, or twist the CFA634.
- Do not place weight or pressure on the CFA634.

12.4. If LCD Panel Breaks

- If the LCD panel breaks, be careful to not get the liquid crystal fluid in your mouth or eyes.
- If the liquid crystal fluid touches your skin, clothes, or work surface, wash it off immediately using warm soapy water.

12.5. Cleaning

- The polarizer (laminated to the glass), is soft plastic that can easily be scratched or damaged, so use extra care when you clean it.
 - Do not clean the polarizer with liquids.
 - Do not wipe the polarizer with any type of cloth or swab (for example, Q-tips).
 - Use the removable protective film to remove smudges (for example, fingerprints), and any foreign matter. If you no longer have the protective film, use standard transparent office tape (for example, Scotch® brand “Crystal Clear Tape”).
 - If the polarizer becomes dusty, carefully blow it off with clean, dry, oil-free compressed air.
 - The polarizer will eventually become hazy if you do not use care when cleaning it.
 - Contact with moisture may permanently spot or stain the polarizer.

12.6. Operation

- Protect the CFA634 from ESD and power supply transients.
- Observe the operating temperature limitations: a minimum of -20°C to a maximum of +70°C with minimal fluctuation. Operation outside of these limits may shorten life and/or harm the display module.
 - At lower temperatures of this range, response time is delayed.
 - At higher temperatures of this range, display becomes dark. (You may need to adjust the contrast.)
- Operate away from dust, moisture, and direct sunlight.
- Adjust backlight brightness so the display is readable, but not too bright.
- Dim or turn off the backlight during periods of inactivity to conserve the backlight lifetime.



/

12.7. Storage and Recycling

- Store in an ESD-approved container away from dust, moisture, and direct sunlight.
- Observe the storage temperature limitations: -30°C minimum, +80°C maximum with minimal fluctuation. Rapid temperature changes can cause moisture to form, resulting in permanent damage.
- Do not allow weight to be placed on the CFA634 while in storage.
- Please recycle your outdated Crystalfontz modules at an approved facility.

13. Mechanical Drawing

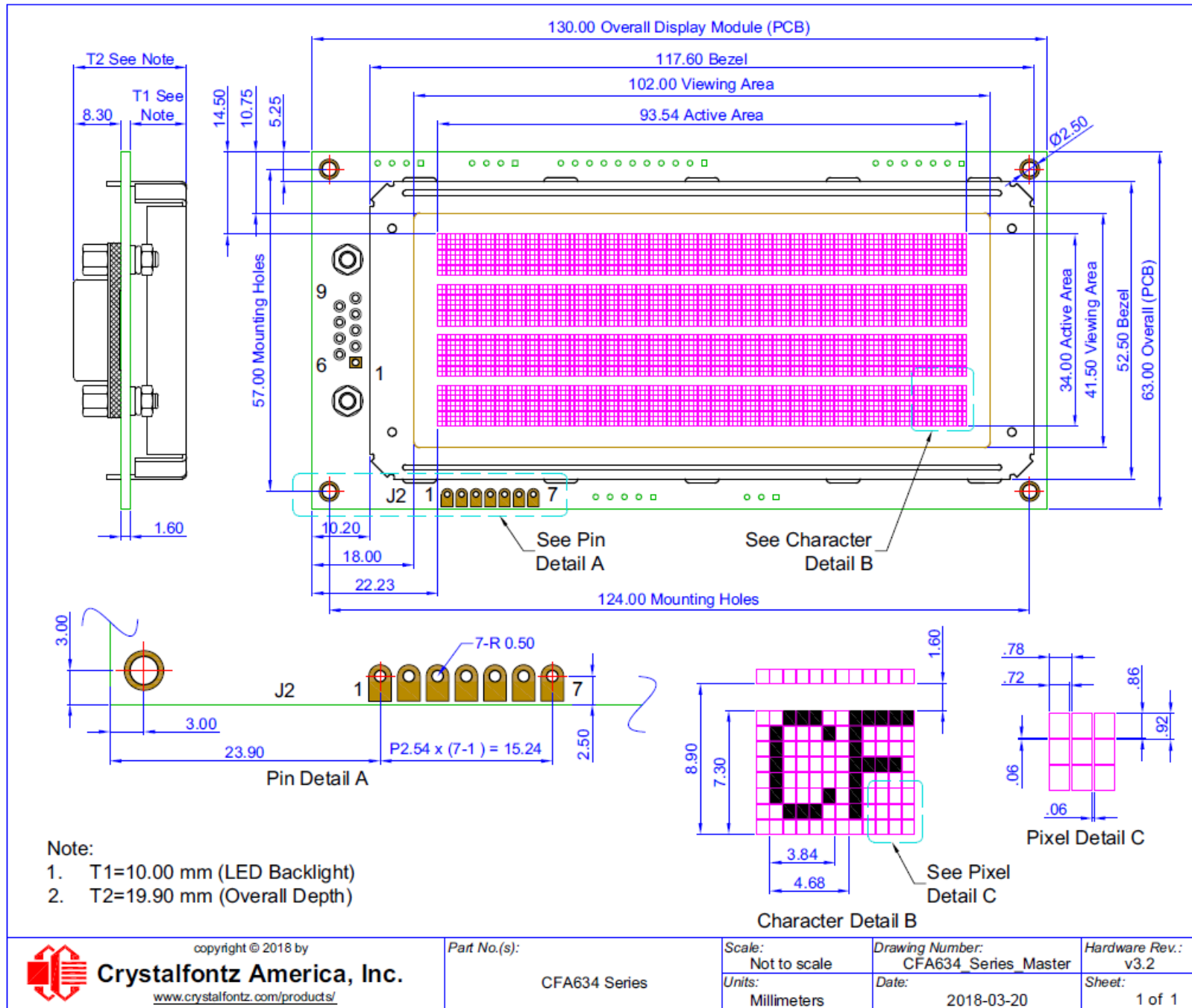



14. Appendix A: Demonstration Software and Sample Code

14.1. Demonstration Software

Demonstration software is available for free download under the Related tab on the website page for each CFA634 part number. Or click on the links in the software descriptions below. No registration is required for download.

14.1.1. cfTest

[cfTest](#) for Windows is testing and configuration software that works on all CrystalFontz Intelligent LCD modules. This software allows you to experiment with the command set for all CrystalFontz Intelligent LCDs.

Streaming communication-based modules (CFA632, CFA634) and packet communication-based modules (CFA533, CFA631, CFA633, CFA635, CFA735, CFA835) are supported. Windows® (XP, Vista, 7, 8), Linux, and Mac (OSX) versions are available.

14.1.2. CrystalControl2 (CC2)

For use with USB and Serial interfaces. [CrystalControl2](#) for Windows displays a great variety of varying information to a CrystalFontz Intelligent LCD Modules in a configurable way. We provide a [User Manual](#) and support through our [forum](#).

14.1.3. Linux_CLI_Examples

[Linux_CLI_Examples](#) is a Linux compatible command-line demonstration program with C source code, 8K.

14.1.4. BasicStamp2

For CFA634-xxx-KS the [BasicStamp2](#) is a simple program that demonstrates communications from a Parallax Basic Stamp.

14.1.5. 632/634 Boot Screen Beta Version

For CFA634-xxx-KS and CFA634-xxx-KU632, [632/634 Boot Screen](#) allows you to change the boot screen and boot behavior, set custom characters, and make logos using multiple custom characters. For use only with display module hardware v.2.4 and below.

14.2. DRIVERS

14.2.1. Linux Driver

See <http://lcdproc.omnipotent.net> for Linux LCD drivers. LCDproc is an open source project that supports many of the CrystalFontz displays.

14.2.2. USB LCD Driver

For CFA634-xxx-KU, the [USB LCD Driver](#) download has self-extracting Microsoft® signed drivers for versions of Windows from XP to current.

NOTE: If you do Windows updates on your PC, Windows USB drivers are automatically included.