

# Crystalfontz America, Inc.

## SPECIFICATION

**CUSTOMER :** \_\_\_\_\_

**MODULE NO.:** **CFAG24064A-YYH-TZ**

SALES BY	APPROVED BY	CHECKED BY	PREPARED BY
<b>ISSUED DATE:</b>			

### Crystalfontz America, Inc.

12412 East Saltese Avenue  
Spokane Valley, WA 99216-0357

Phone: (888) 206-9720

Fax: (509) 892-1203

Email: [techinfo@crystalfontz.com](mailto:techinfo@crystalfontz.com)

URL: [www.crystalfontz.com](http://www.crystalfontz.com)

# Contents

1. Module Classification Information
2. Precautions in use of LCD Modules
3. General Specification
4. Absolute Maximum Ratings
5. Electrical Characteristics
6. Optical Characteristics
7. Interface Description
8. Contour Drawing & Block Diagram
9. Display Control Instruction
10. Timing Characteristics
11. Reliability
12. Backlight Information
13. Material List of Components for RoHS

# 1. Module Classification Information

CFA G 24064 AYYH TZ  
 ① ② ③ ④⑤⑥⑦ ⑧

①	Brand: <b>CRYSTALFONTZ AMERICA, INC</b>	
②	Display Type: H→Character Type, <b>G→Graphic Type</b>	
③	Displays Logical Dimensions: <b>240 pixels by 64 pixels</b>	
④	Model PCB Variant: <b>A</b>	
⑤	Backlight Type:	N→Without backlight B→EL, Blue green D→EL, Green W→EL, White F→CCFL, White <b>Y→LED, Yellow Green</b> T→LED, White A→LED, Amber R→LED, Red O→LED, Orange G→LED, Green
⑥	LCD Mode:	B→TN Positive, Gray    T→FSTN Negative N→TN Negative, G→STN Positive, Gray <b>Y→STN Positive, Yellow Green</b> M→STN Negative, Blue F→FSTN Positive
⑦	LCD Polarizer Type/ Temperature range/ View direction	A→Reflective, N.T, 6:00 <b>H→Transflective, W.T,6:00</b> D→Reflective, N.T, 12:00    K→Transflective, W.T,12:00 G→Reflective, W. T, 6:00    C→Transmissive, N.T,6:00 J→Reflective, W. T, 12:00    F→Transmissive, N.T,12:00 B→Transflective, N.T,6:00    I→Transmissive, W. T, 6:00 E→Transflective, N.T.12:00    L→Transmissive, W.T,12:00
⑧	Special Code	<b>T→Built in Negative Voltage &amp; Temperature Compensation</b> <b>Z→ICNT7086</b>

## **2.Precautions in use of LCD Modules**

- (1) Avoid applying excessive shocks to the module or making any alterations or modifications to it.
- (2) Don't make extra holes on the printed circuit board, modify its shape or change the components of LCD module.
- (3) Don't disassemble the LCM.
- (4) Don't operate it above the absolute maximum rating.
- (5) Don't drop, bend or twist LCM.
- (6) Soldering: only to the I/O terminals.
- (7) Storage: please storage in anti-static electricity container and clean environment.

## **3.General Specification**

<b>Item</b>	<b>Dimension</b>	<b>Unit</b>
Number of Characters	240*64 dot	—
Module dimension	180.0 x 65.0 x 17.0(MAX)	mm
View area	133.0 x 39.0	mm
Active area	127.16 x 33.88	mm
Dot size	0.49 x 0.49	mm
Dot pitch	0.53 x 0.53	mm
LCD type	STN, Positive Transflective ; Yellow Green	
Duty	1/64	
View direction	6 o'clock	
Backlight Type	LED, Yellow Green	

## **4. Absolute Maximum Ratings**

Item	Symbol	Min	Typ	Max	Unit
Operating Temperature	$T_{OP}$	-20	—	+70	°C
Storage Temperature	$T_{ST}$	-30	—	+80	°C
Input Voltage	$V_I$	$V_{SS}$	—	$V_{DD}$	V
Supply Voltage For Logic	$V_{DD}-V_{SS}$	-0.3	—	+7	V
Supply Voltage For LCD	$V_{DD}-V_0$	0	—	15	V

## **5. Electrical Characteristics**

Item	Symbol	Condition	Min	Typ	Max	Unit
Supply Voltage For Logic	$V_{DD}-V_{SS}$	—	4.75	5.0	5.25	V
Supply Voltage For LCD	$V_{DD}-V_0$	$T_a=-20^{\circ}\text{C}$	—	—	13.9	V
		$T_a=25^{\circ}\text{C}$	—	12.5	—	V
		$T_a=+70^{\circ}\text{C}$	—	—	—	V
			10.1	—	—	
Input High Volt.	$V_{IH}$	—	$V_{DD}-2.2$	—	$V_{DD}$	V
Input Low Volt.	$V_{IL}$	—	0	—	0.8	V
Output High Volt.	$V_{OH}$	—	$V_{DD}-0.3$	—	$V_{DD}$	V
Output Low Volt.	$V_{OL}$	—	0	—	0.3	V
Supply Current	$I_{DD}$	$V_{DD}=5\text{V}$	12	16	20	mA

# 6. Optical Characteristics

Item	Symbol	Condition	Min	Typ	Max	Unit
View Angle	(V) $\theta$	$CR \geq 2$	20	—	40	deg
	(H) $\phi$	$CR \geq 2$	-30	—	30	deg
Contrast Ratio	CR	—	—	3	—	—
Response Time	T rise	—	—	150	200	ms
	T fall	—	—	150	200	ms

### Definition of Operation Voltage (Vop)

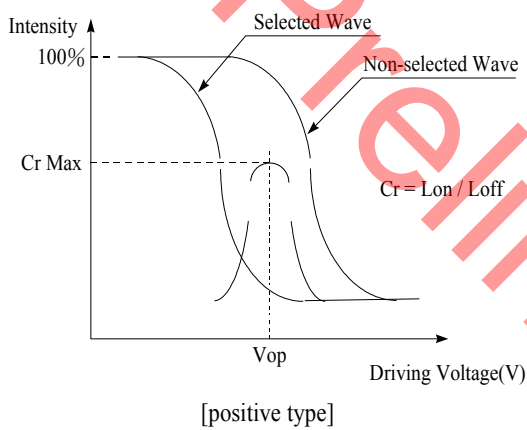

### Definition of Response Time (Tr, Tf)

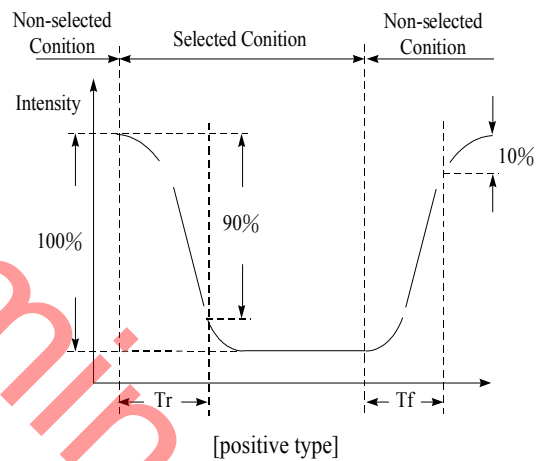

### Conditions :

Operating Voltage : Vop

Viewing Angle( $\theta, \phi$ ) :  $0^\circ, 0^\circ$

Frame Frequency : 64 HZ

Driving Waveform : 1/N duty , 1/a bias

### Definition of viewing angle( $CR \geq 2$ )

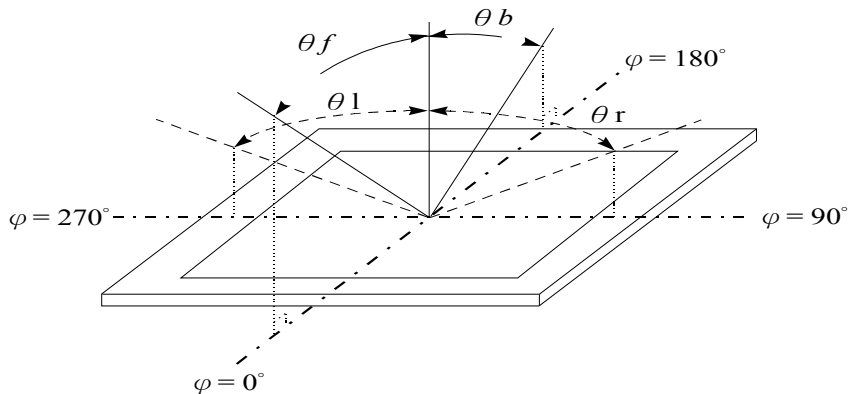

## 7. Interface Description

Pin No.	Symbol	Level	Description
1	FG	—	Frame ground ( Connected to bezel )
2	V <sub>ss</sub>	—	GND
3	V <sub>dd</sub>	—	Power supply ( +5 V )
4	V <sub>o</sub>	—	Power supply for LCD driver
5	/WR	L	Data write. Write data into T6963C when WR = L
6	/RD	L	Data read. Read data from T6963C when RD = L
7	/CE	L	L : Chip enable
8	C/D	H / L	WR=L , C/D=H : Command Write C/D=L: Data write RD=L , C/D=H : Status Read C/D=L: Data read
9	V <sub>ee</sub>	—	Negative voltage -10V output
10	/RESET	H / L	H : Normal ; L : Initialize T6963C
11	DB0	H / L	Data bus line
12	DB1	H / L	Data bus line
13	DB2	H / L	Data bus line
14	DB3	H / L	Data bus line
15	DB4	H / L	Data bus line
16	DB5	H / L	Data bus line
17	DB6	H / L	Data bus line
18	DB7	H / L	Data bus line
19	FS	H / L	Pins for selection of font; H : 6 * 8 , L : 8 * 8
20	N.C	—	No connection

# 8. Contour Drawing & Block Diagram

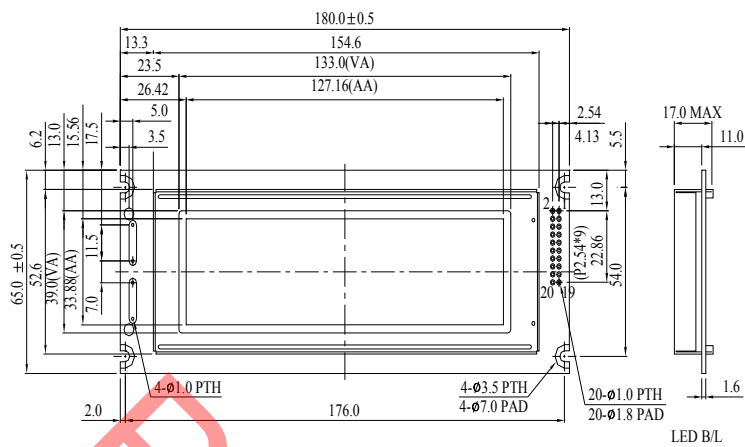

The non-specified tolerance of dimension is  $\pm 0.3\text{mm}$ .

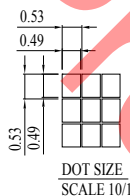

PIN NO.	SYMBOL
1	FGND
2	Vss
3	Vdd
4	Vo
5	WR
6	RD
7	CE
8	C/D
9	Vee
10	RESET
11	DB0
12	DB1
13	DB2
14	DB3
15	DB4
16	DB5
17	DB6
18	DB7
19	FS
20	NC

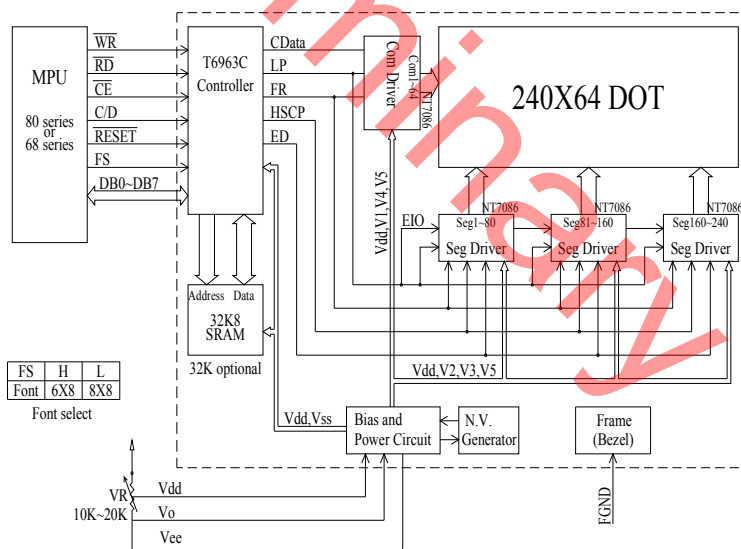

External contrast adjustment.



## **9.Display control instruction**

The LCD Module has built in a T6963C LSI controller, It has an 8-bit parallel data bus and control lines for writing or reading through an MPU interface, it has a 128-word character generator ROM ( refer to Table 1. ), which can control an external display RAM of up to 8K bytes. Allocation of text, graphics and external character generator RAM can be made easily and the display window can be moved freely within the allocated memory range.

### **•RAM Interface**

The external RAM is used to store display data( text, graphic and external CG data ). It can be freely allocated to the memory area( 8 K byte max ).

Recommend

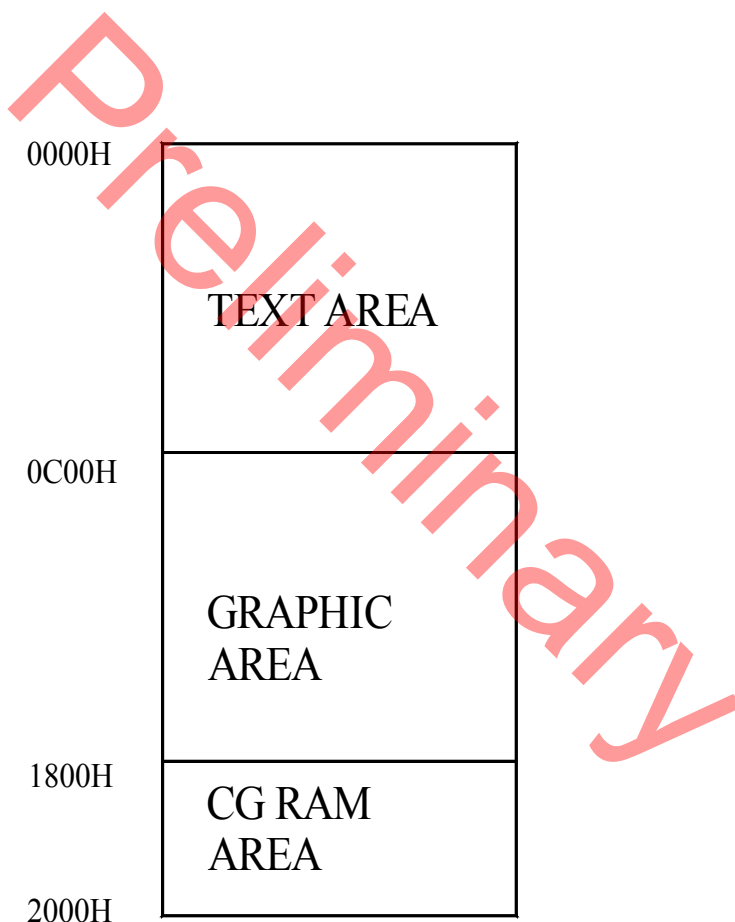

·Flowchart of communications with MPU

(1) Status Read

A status check must be performed before data is read or written.

Status check

The Status of T6963C can be read from the data lines.

$\overline{RD}$  L

$\overline{WR}$  H

$\overline{CE}$  L

C/D H

Do to D7 H

The T6963C status word format is as follows:

MSB							LSB
STA7	STA6	STA5	STA4	STA3	STA2	STA1	STA0
D7	D6	D5	D4	D3	D2	D1	D0

STA0	Check command execution capability	0:Disable 1:Enable
STA1	Check data read/write Capability	0:Disable 1:Enable
STA2	Check Auto mode data read capability	0:Disable 1:Enable
STA3	Check Auto mode data write capability	0:Disable 1:Enable
STA4	Not used	—
STA5	Check controller operation capability	0:Disable 1:Enable
STA6	Error flag. Used for Screen Peek and Screen copy commands.	0:No error 1:Error
STA7	Check the blink condition	0:Disable off 1:Normal display

(Note 1) It is necessary to check STA0 and STA1 at the same time.

There is a possibility of erroneous operation due to a hardware interrupt.

(Note 2) For most modes STA0/STA1 are used as a status check.

(Note 3) STA2 and STA3 are valid in Auto mode; STA0 and STA1 are invalid.

Status Checking flow

(a)

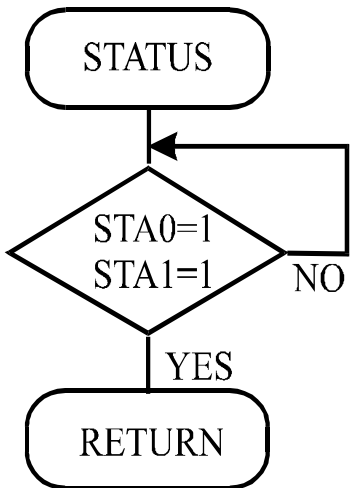

(b)

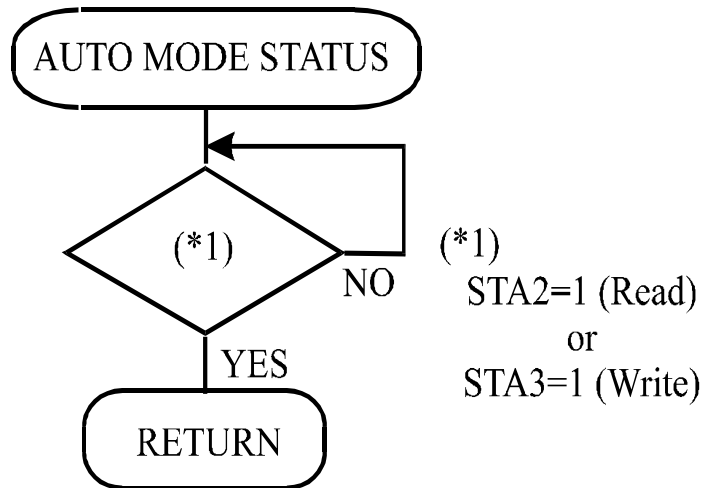

(Note 4) When using the MSB=0 command, a Status Read must be performed.

If a status check is not carried out, the T6963C cannot operate normally, even after a delay time.

The hardware interrupt occurs during the address calculation period (at the end of each line).

If a MSB=0 command is sent to the T6963C during this period, the T6963C enters Wait status.

If a status check is not carried out in this state before the next command is sent, there is the possibility that the command or data date will not be received.

(2) Setting date

When using the T6963C, first set the data, then set the command.

Procedure for sending a command

(a) The case of 1 data

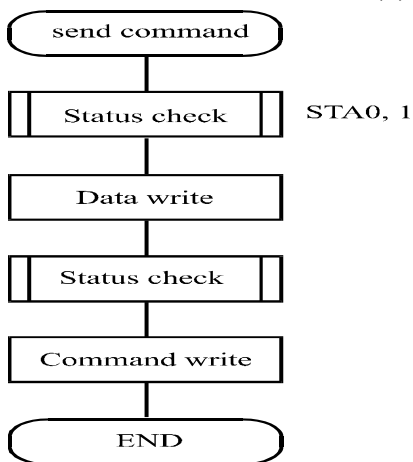

(b) The case of 2 data

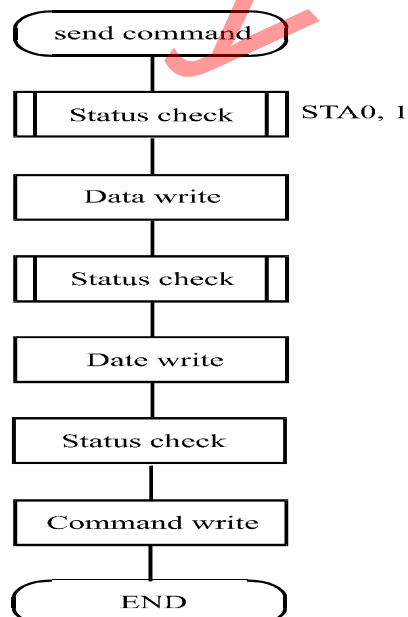

(Note) When sending more than two data, the last datum (or last two data) is valid.

· COMMAND DEFINITIONS

COMMAND	CODE	D1	D2	FUNCTION
REGISTERS SETTING	00100001	X address	Y address	Set Cursor Pointer
	00100010	Date	00H	Set Offset Register
	00100100	Low address	High address	Set Address Pointer
SET CONTROL WORD	01000000	Low address	High address	Set Text Home Address
	01000001	Columns	00H	Set Text Area
	01000010	Low address	High address	Set Graphic Home Address
	01000011	Columns	00H	Set Graphic Area
MODE SET	1000×000	—	—	OR mode
	1000×001	—	—	EXOR mode
	1000×011	—	—	AND mode
	1000×100	—	—	Text Attribute mode
	10000×××	—	—	Internal CG ROM mode
	10001×××	—	—	External CG RAM mode
DISPLAY MODE	10010000	—	—	Display off
	1001××10	—	—	Cursor on, blink off
	1001××11	—	—	Cursor on, blink on
	100101××	—	—	Text on, graphic off
	100110××	—	—	Text off, graphic on
	100111××	—	—	Text on, graphic on
CURSOR PATTERN SELECT	10100000	—	—	1-line cursor
	10100001	—	—	2-line cursor
	10100010	—	—	3-line cursor
	10100011	—	—	4-line cursor
	10100100	—	—	5-line cursor
	10100101	—	—	6-line cursor
	10100110	—	—	7-line cursor
	10100111	—	—	8-line cursor
DATA AUTO READ/WRITE	10110000	—	—	Set Data Auto Write
	10110001	—	—	Set Data Auto Read
	10110010	—	—	Auto Reset
DATA READ/WRITE	11000000	Data	—	Data Write and Increment ADP
	11000001	—	—	Data Read and Increment ADP
	11000010	Data	—	Data Write and Decrement ADP
	11000011	—	—	Data Read and Decrement ADP Data
	11000100	Data	—	Write and Non variable ADP
	11000101	—	—	Data Read and Non variable ADP
SCREEN PEEK	11100000	—	—	Screen Peek

X : invalid

COMMAND	CODE	D1	D2	FUNCTION
SCREEN COPY	11101000	—	—	Screen Copy
BIT SET/RESET	11110×××	—	—	Bit Reset
	11111×××	—	—	Bit Set
	1111× 001	—	—	Bit 0 (LSB)
	1111× 001	—	—	Bit 1
	1111× 010	—	—	Bit 2
	1111× 011	—	—	Bit 3
	1111× 100	—	—	Bit 4
	1111× 101	—	—	Bit 5
	1111× 110	—	—	Bit 6
	1111× 110	—	—	Bit 7 (MSB)

X: invalid

· Setting registers

CODE	HEX.	FUNCTION	D1	D2
00100001	21H	SET CURSOR POINTER	X ADRS	Y ADRS
00100010	23H	SET OFFSET REGISTER	DATA	00H
00100100	24H	SET ADDRESS POINTER	LOW ADRS	HIGH ADRS

(1) Set Cursor Pointer

The position of the cursor is specified by X ADRS and Y ADRS. The cursor position can only be moved by this command. Data read/write from the MPU never changes the cursor pointer. X ADRS and Y ADRS are specified as follows.

X ADRS 00H to 4FH (lower 7 bits are valid)

Y ADRS 00H to 1FH (lower 5 bits are valid)

Single-Scan

X ADRS 00 to 4FH



(2) Set Offset Register

The offset register is used to determine the external character generator RAM area.

The T6963C has a 16-bit address bus as follows.

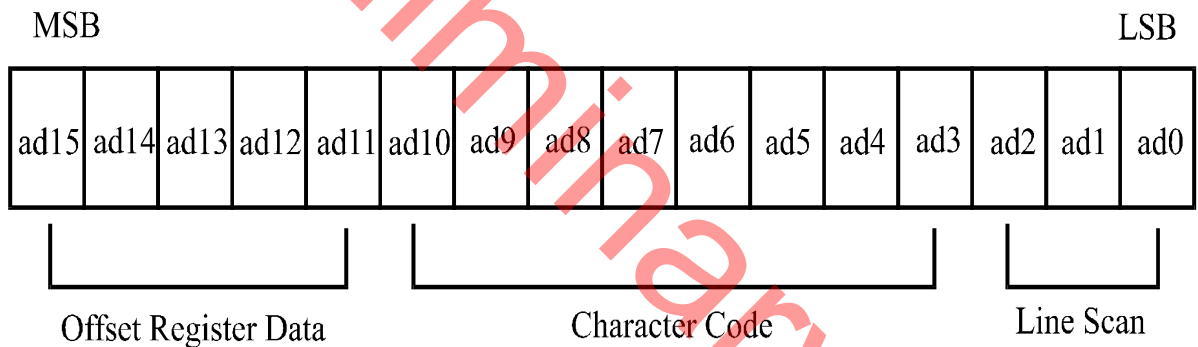

T6963C assign External character generator, when character code set 80H TO FFH in using internal character generator. Character code 00H to 80H assign External character generator, when External generator mode.

The senior five bits define the start address in external memory of the CG RAM area. The next eight bits represent the character code of the character. In internal CG ROM, character codes 00H to 7FH represent the predefined “internal” CG ROM characters, and codes 80H to FFH represent the user’s own “external” characters. In external CG ROM mode, all 256 codes from 00H to FFH can be used to represent the user’s own characters. The three least significant bits indicate one of the eight rows of eight dots that define the character’s shape.

The relationship between display RAM address and offset register

Offset register data	CG RAM hex. address (start to end)
00000	0000 to 07 FFH
00001	0800 to 0FFFH
00010	1000 to 17FFH
11100	E000 to E7FFH
11101	E800 to EFFFH
11110	F000 to F7FFH
11111	F800 to FFFFH

(Example 1)

Offset register	02H
Character code	80H
Character generator RAM start address	0001 0100 0000 0000
	1 4 0 0 H

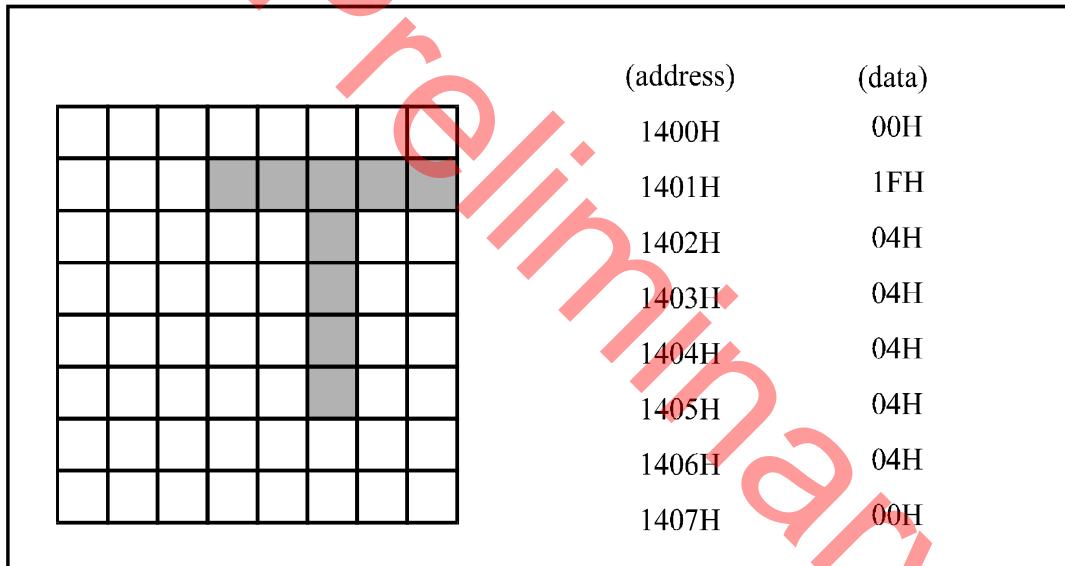

(Example 2) The relationship between display RAM data and display characters

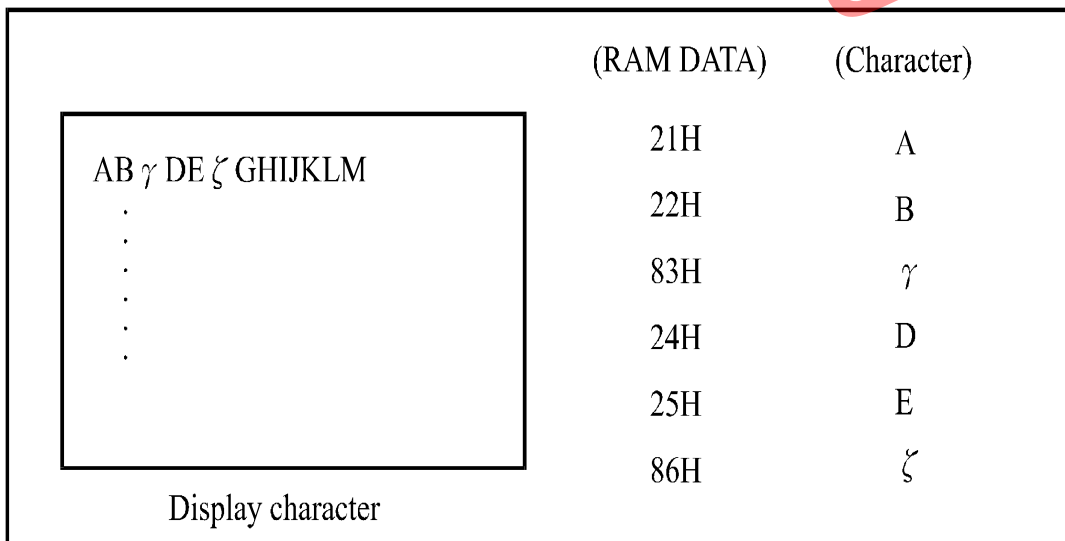

γ and ζ are displayed by character generator RAM.

### (3) Set Address Pointer

The Set Address Pointer command is used to indicate the start address for writing to (or reading from) external RAM.

The Flowchart for Set Address Pointer command

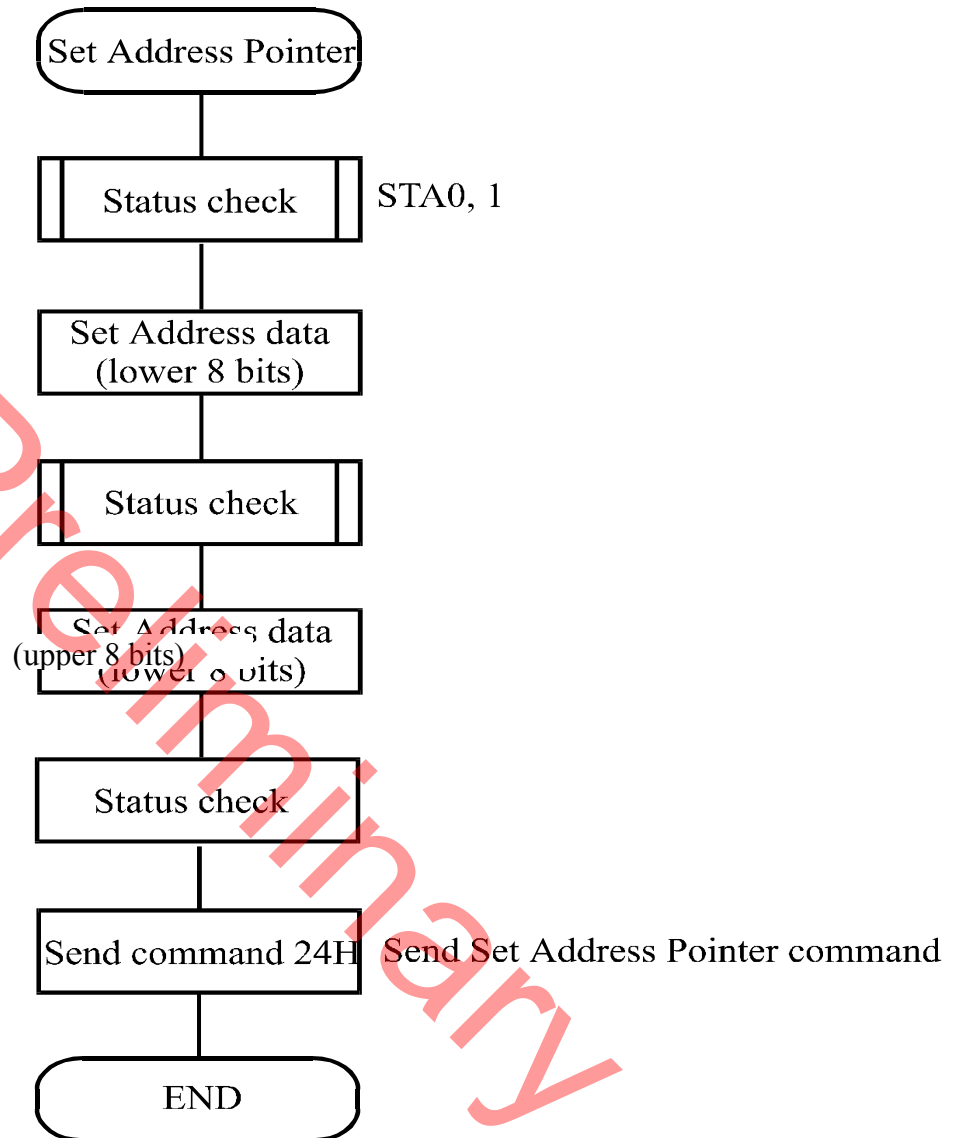

· Set Control Word

CODE	HEX.	FUNCTION	D1	D2
01000000	40H	Set Text Home Address	Low address	High address
01000001	41H	Set Text Area	Columns	00H
01000010	42H	Set Graphic Home Address	Low address	High address
01000011	43H	Set Graphic Area	Columns	00H

The home address and column size are defined by this command.

(1) Set Text Home Address

The starting address in the external display RAM for text display is defined by this command.

The text home address indicates the leftmost and uppermost position.

The relationship between external display RAM address and display position

TH	—	TH+CL
TH+TA	—	TH+TA+CL
(TH+TA)+TA	—	TH+2TA+CL
(TH+2TA)+TA	—	TH+3TA+CL
—	—	
TH+(n-1) TA	—	TH+(n-1) TA+CL

TH: Text home address

TA: Text area number (columns)

CL: Columns are fixed by hardware (pin-programmable).

(Example)

Text home address : 0000H  
 Text area : 0020H  
 : 32 Columns  
 : 4 Lines

0000H	0001H	—	001EH	001FH
0020H	0021H	—	003EH	002FH
0040H	0041H	—	005EH	005FH
0060H	0061H	—	007EH	007FH



(2) Set Graphic Home Address

The starting address of the external display RAM used for graphic display is defined by this command. The graphic home address indicates the leftmost and uppermost position.

The relationship between external display RAM address and display position

GH	—	GH+GL
GH+GA	—	GH+GA+CL
(GH+GA)+GA	—	GH+2GA+CL
(GH+2GA)+GA	—	GH+3GA+CL
—	—	—
GH+(n-1) GA	—	GH+(n-1) GA+CL

GH: Graphic home address

GA: Graphic area number (columns)

CL: Columns are fixed by hardware (pin-programmable).

(Example)

Graphic home address : 0000H

Graphic area : 0020H

: 32 Columns

: 2 Lines

0000H	0001H	—	001EH	001FH
0020H	0021H	—	003EH	003FH
0040H	0041H	—	005EH	005FH
0060H	0061H	—	007EH	007FH
0080H	0081H	—	009EH	009FH
00A0H	00A1H	—	00BEH	00BFH
00C0H	00C1H	—	00DEH	00DFH
00E0H	00E1H	—	00FEH	00FFH
0100H	0101H	—	011EH	011FH
0120H	0121H	—	013EH	013FH
0140H	0141H	—	015EH	014FH
0160H	0161H	—	017EH	017FH
0180H	0181H	—	109EH	019FH
01A0H	01A1H	—	01BEH	01BFH
01C0H	01C1H	—	01DEH	01DFH
01E0H	01E1H	—	01FEH	01FFH





· Mode set

CODE	FUNCTION	OPERAND
1000x000	OR Mode	—
1000x001	EXOR Mode	—
1000x011	AND Mode	—
1000x100	TEXT ATTRIBUTE Mode	—
10000xxx	Internal Character Generator Mode	—
10001xxx	External Character Generator Mode	—

X: invalid

The display mode is defined by this command. The display mode does not change until the next command is sent. The logical OR, EXOR, AND of text or graphic display can be displayed. In Internal Character Generator mode, character codes 00H to 7FH are assigned to the built-in character generator ROM. The character codes 80H to FFH are automatically assigned to the external character generator RAM.

(Example)

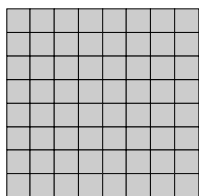

GRAPHIC

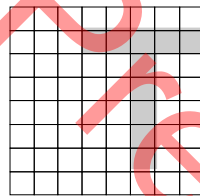

TEXT

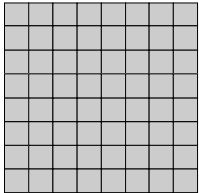

“OR”

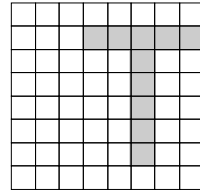

“AND”

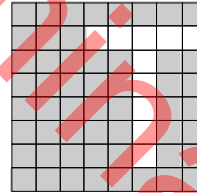

“TXOR”

(Note) Attribute functions can only be applied to text display, since the attribute data is placed in the graphic RAM area.

Attribute function

The attribute operations are Reverse display, Character blink and Inhibit. The attribute data is written into the graphic area which was defined by the Set Control Word command. Only text display is possible in Attribute Function mode; graphic display is automatically disabled. However, the Display Mode command must be used to turn both Text and Graphic on in order for the Attribute function to be available.

The attribute data for each character in the text area is written to the same address in the graphic area. The Attribute function is defined as follows.

Attribute RAM 1byte

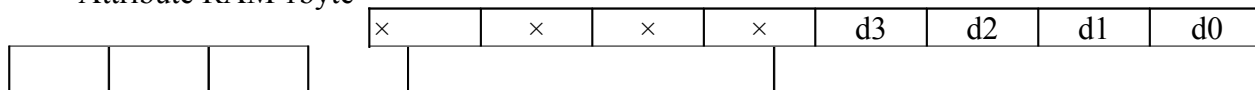

d3	d2	d1	d0	FUNCTION
0	0	0	0	Normal display
0	1	0	1	Reverse display
0	0	1	1	Inhibit display
1	0	0	0	Blink of normal display
1	1	0	1	Blink of reverse display
1	0	1	1	Blink of inhibit display

X: invalid

Preliminary

·Display mode

CODE	FUNCTION	OPERAND
10010000	Display off	—
1001xx10	Cursor on, blink off	—
1001xx11	Cursor on, blink on	—
100101xx	Text on, graphic off	—
100110xx	Text off, graphic on	—
100111xx	Text on, graphic on	—

X:invalid

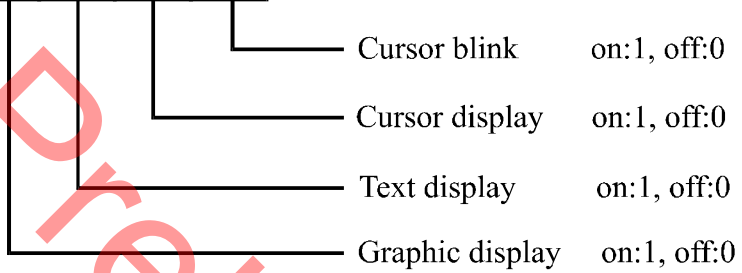
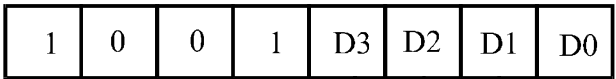

(Note) It is necessary to turn on “Text display” and “Graphic display” in the following cases.

- a) Combination of text/graphic display
- b) Attribute function

Preliminary

·Cursor pattern select

CODE	FUNCTION	OPERAND
10100000	1-line cursor	—
10100001	2-line cursor	—
10100010	3-line cursor	—
10100011	4-line cursor	—
10100100	5-line cursor	—
10100101	6-line cursor	—
10100110	7-line cursor	—
10100111	8-line cursor	—

When cursor display is ON, this command selects the cursor pattern in the range 1 line to 8 lines. The cursor address is defined by the Cursor Pointer Set command.

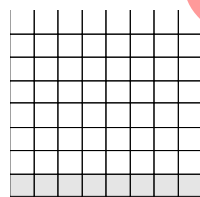

1-line cursor

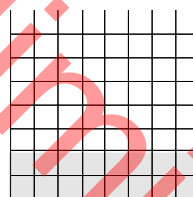

2-line cursor

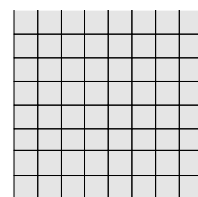

8-line cursor

·Data Auto Read/Write

CODE	HEX.	FUNCTION	OPERAND
10110000	B0H	Set Data Auto Write	—
10110001	B1H	Set Data Auto Read	—
10110010	B2H	Auto Reset	—

The command is convenient for sending a full screen of data from the external display RAM. After setting Auto mode, a Data Write (or Read) command is need not be sent between each datum. A Data Auto Write (or Read) command must be sent after a Set Address Pointer command. After this command, the address pointer is automatically incremented by 1 after each datum. In Auto mode, the T6963C cannot accept any other commands.

The Auto Reset command must be sent to the T69963C after all data has been sent, to clear Auto mode.

(Note) A Status check for Auto mode

(STA2, STA3 should be checked between sending of each datum. Auto Reset should be performed after checking STA3=1 (STA2=1.) Refer to the following flowchart.

Preliminary



a)Auto Read mode

b)Auto Write mode

Preliminary

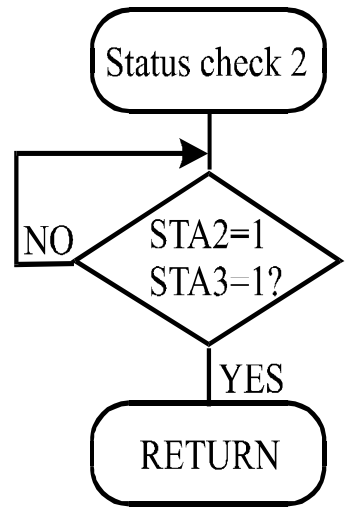
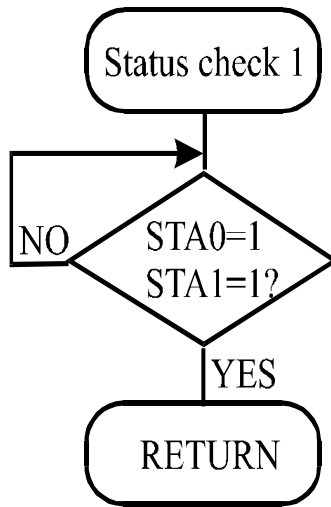
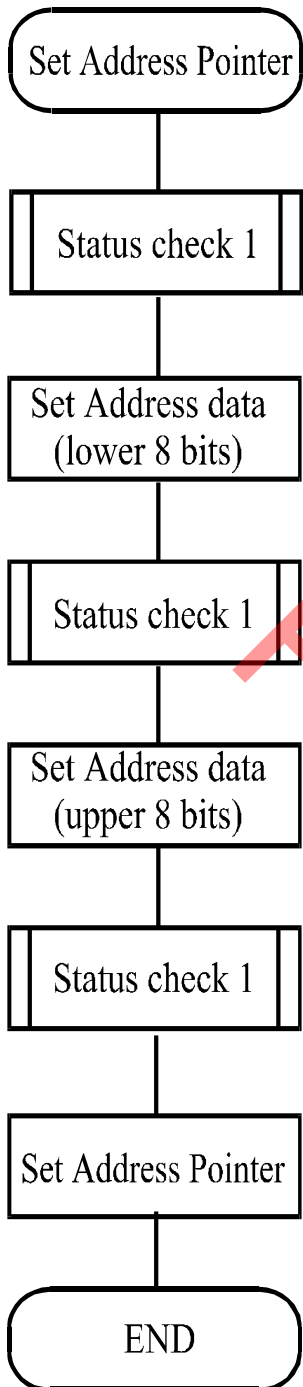

Preliminary

·Date Read/Write

CODE	HEX.	FUNCTION	OPERAND
11000000	C0H	Data Write and Increment ADP	Data
11000001	C1H	Data Read and Increment ADP	—
11000010	C2H	Data Write and Decrement ADP	Data
11000011	C3H	Data Read and Decrement ADP	—
11000100	C4H	Data Write and Non variable ADP	Data
11000101	C5H	Data Read and Non variable ADP	—

This command is used for writing data from the MPU to external display RAM, and reading data from external display RAM to the MPU. Data Write/Data Read should be executed after setting address using Set Address Pointer command. The address pointer can be automatically incremented or decremented using this command.

(Note) This command is necessary for each 1-byte datum.

Refer to the following flowchart.

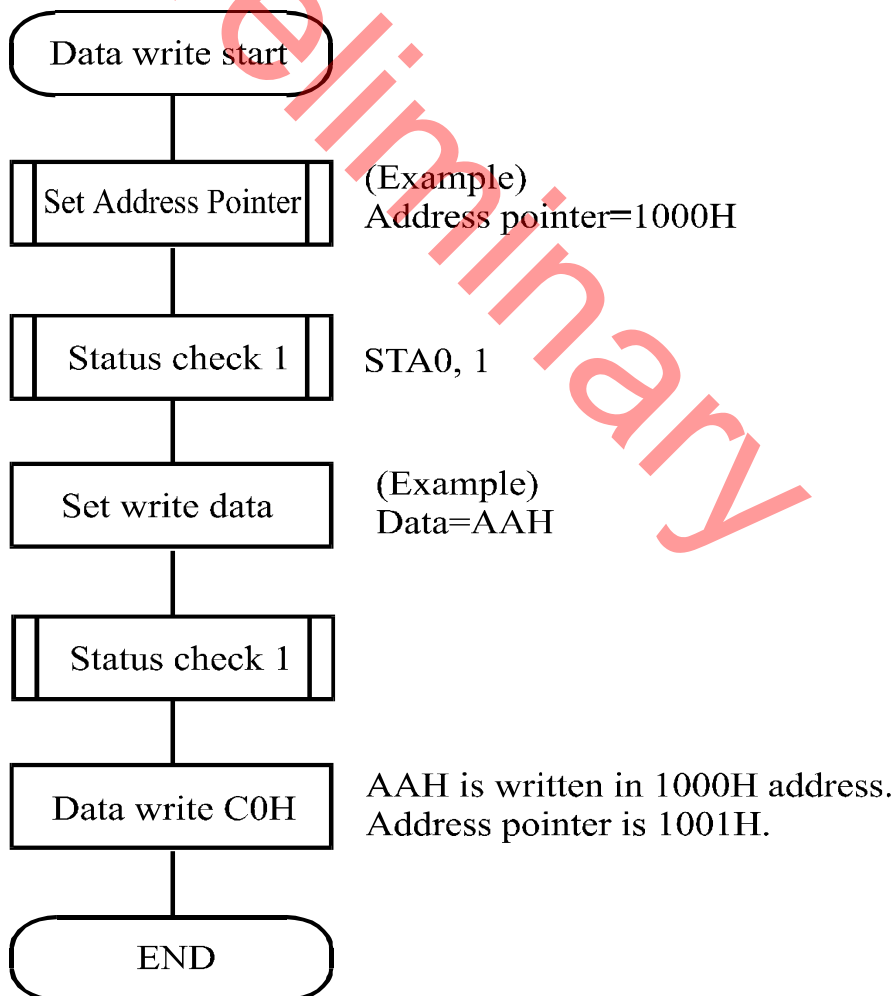

·Screen Peek

CODE	HEX.	FUNCTION	OPERAND
11100000	E0H	Screen Peek	-e

This command is used to transfer 1 byte of displayed data to the data stack; this byte can then be read from the MPU by data access. The logical combination of text and graphic display data on the LCD screen can be read by this command.

The status (STA6) should be checked just after the Screen Peek command. If the address determined by the Set Address Pointer command is not in the graphic area, this command is ignored and a status flag (STA6) is set.

Refer to the following flowchart.

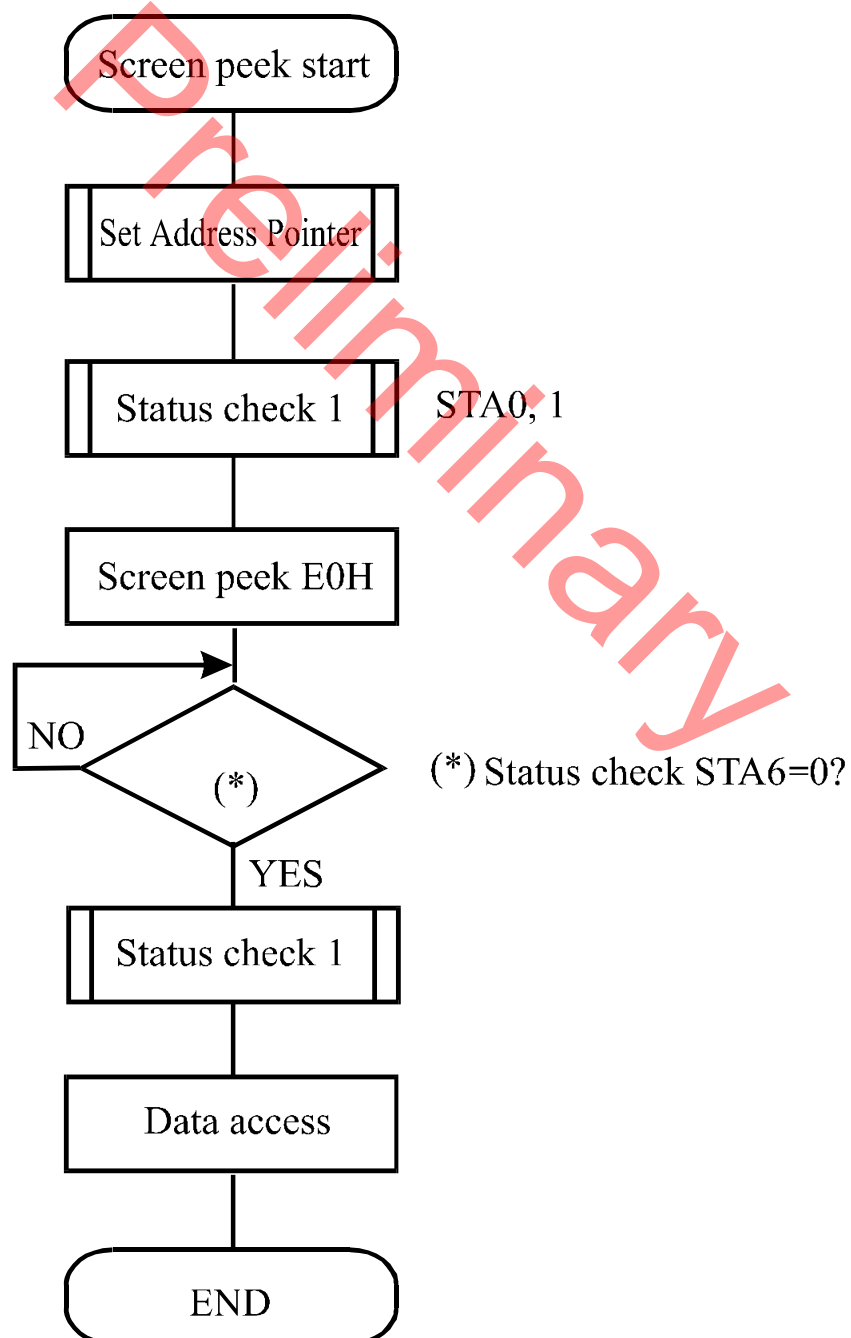

·Screen Copy

CODE	HEX.	FUNCTION	OPERAND
11101000	E8H	Screen Copy	—

This command copies a single raster line of data to the graphic area.

The start point must be set using the Set Address Pointer command.

(Note 1) If the attribute function is being used, this command is not available.

(With Attribute data is graphic area data.)

Refer to the following flowchart.

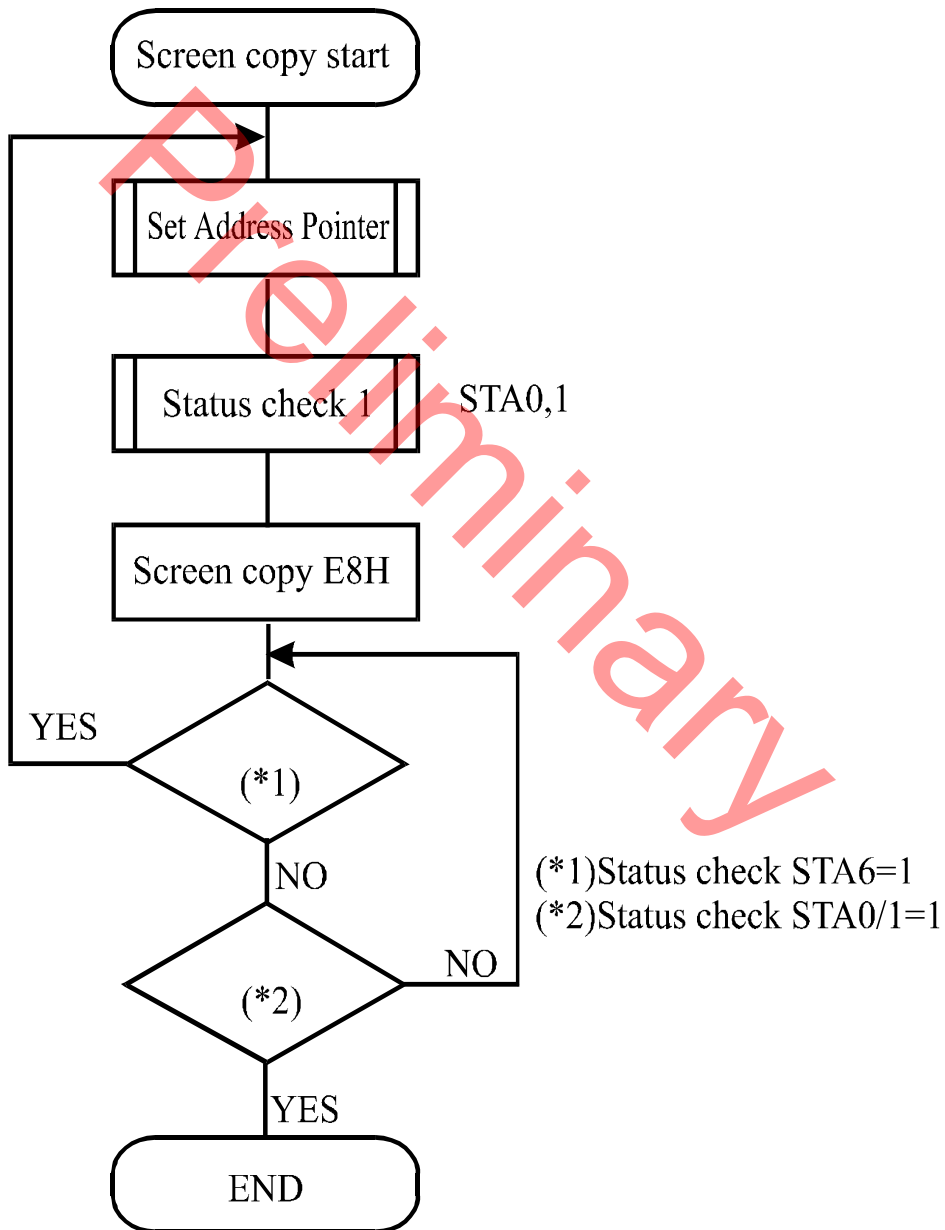

• Bit Set/Reset

CODE	FUNCTION	OPERAND
11110xxx	Bit Reset	—
11111xxx	Bit Set	—
1111x000	Bit 0 (LSB)	—
1111x001	Bit 1	—
1111x010	Bit 2	—
1111x011	Bit 3	—
1111x100	Bit 4	—
1111x101	Bit 5	—
1111x110	Bit 6	—
1111x111	Bit 7 (MSB)	—

X: invalid

This command use to set or reset a bit of the byte specified by the address pointer.  
 Only one bit can be set/reset at a time.  
 Refer to the following flowchart.

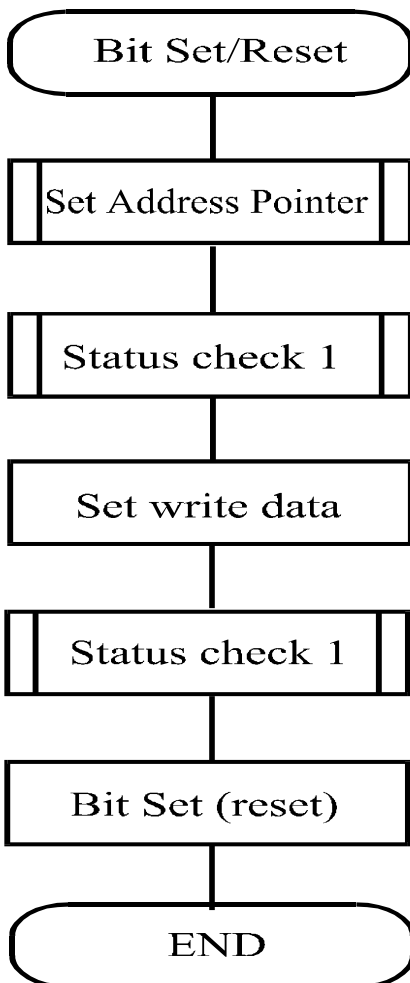

STA0,1



# 10. Timing Characteristics

## Bus Timing

( $V_{SS} = 0\text{ V}$ ,  $V_{DD} = 5\text{ V}$ )

Item	Symbol	Min	Typ	Max	Unit
C/D Set-up Time	$t_{CDS}$	100	—	—	ns
C/D Hold Time	$t_{CDH}$	10	—	—	ns
CE, RD, WR Pulse Width	$t_{CDS}$ , $t_{RD}$ , $t_{WR}$	80	—	—	ns
Data Set-up Time	$t_{DS}$	80	—	—	ns
Data Hold Time	$t_{DH}$	40	—	—	ns
Access Time	$t_{ACC}$	—	—	150	ns
Output Hold Time	$t_{OH}$	10	—	50	ns

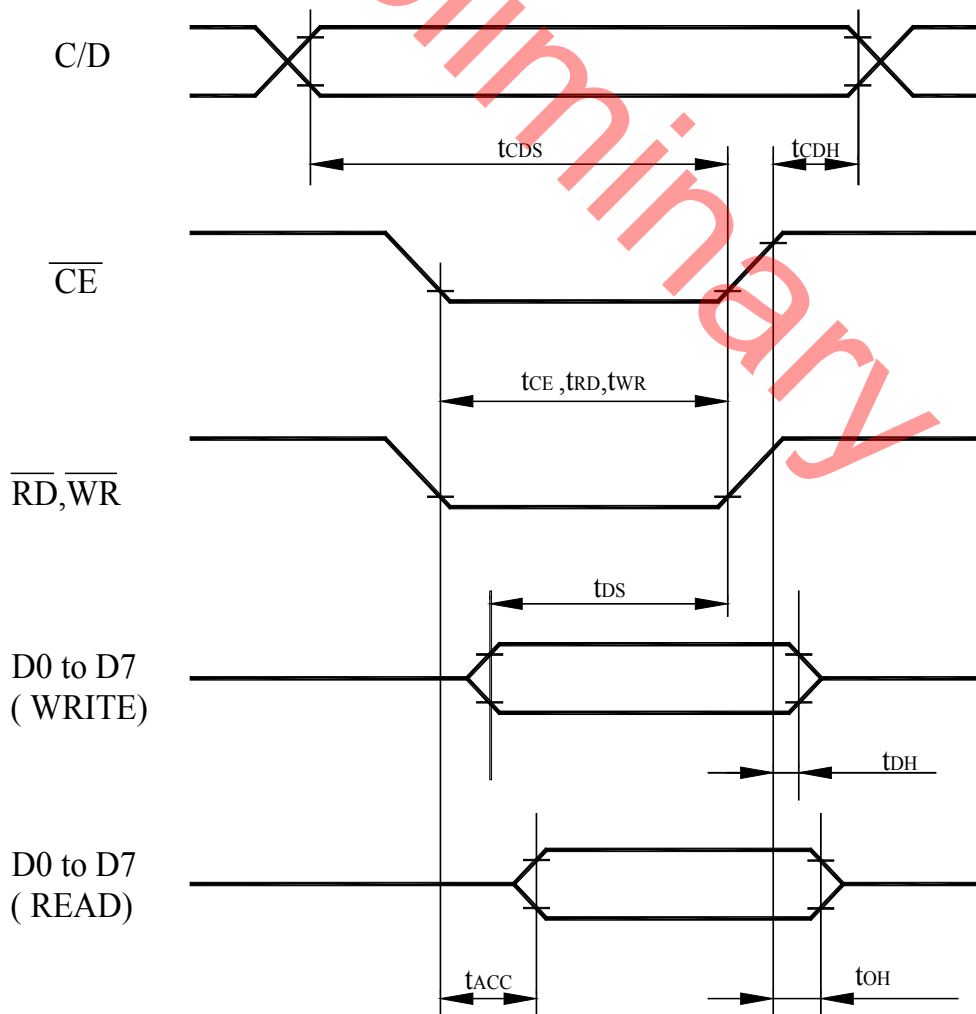



# 11. Reliability

## Content of Reliability Test (wide temperature, -20°C~70°C)

Environmental Test			
Test Item	Content of Test	Test Condition	Note
High Temperature storage	Endurance test applying the high storage temperature for a long time.	80°C 200hrs	2
Low Temperature storage	Endurance test applying the high storage temperature for a long time.	-30°C 200hrs	1,2
High Temperature Operation	Endurance test applying the electric stress (Voltage & Current) and the thermal stress to the element for a long time.	70°C 200hrs	—
Low Temperature Operation	Endurance test applying the electric stress under low temperature for a long time.	-20°C 200hrs	1
High Temperature/ Humidity Operation	The module should be allowed to stand at 60°C,90%RH max For 96hrs under no-load condition excluding the polarizer, Then taking it out and drying it at normal temperature.	60°C,90%RH 96hrs	1,2
Thermal shock resistance	The sample should be allowed stand the following 10 cycles of operation -20°C 25°C 70°C  30min 5min 30min 1 cycle	-20°C/70°C 10 cycles	—
Vibration test	Endurance test applying the vibration during transportation and using.	Total fixed amplitude : 1.5mm Vibration Frequency : 10~55Hz One cycle 60 seconds to 3 directions of X,Y,Z for Each 15 minutes	3
Static electricity test	Endurance test applying the electric stress to the terminal.	VS=800V,RS=1.5kΩ CS=100pF 1 time	—

**Note1: No dew condensation to be observed.**

**Note2: The function test shall be conducted after 4 hours storage at the normal Temperature and humidity after remove from the test chamber.**

**Note3: Vibration test will be conducted to the product itself without putting it in a container.**

# 12. Backlight Information

## Specification

PARAMETER	SYMBOL	MIN	TYP	MAX	UNIT	TEST CONDITION
Supply Current	I <sub>LED</sub>	528	660	990	mA	V=4.2V
Supply Voltage	V	4.0	4.2	4.4	V	—
Reverse Voltage	V <sub>R</sub>	—	—	10	V	—
Luminous Intensity	I <sub>V</sub>	139.6	174.5	—	CD/M <sup>2</sup>	I <sub>LED</sub> =660mA
Wave Length	λ <sub>p</sub>	—	570	—	nm	I <sub>LED</sub> =660mA
Life Time	—	—	100000	—	Hr.	I <sub>LED</sub> =660mA
Color	Yellow Green					

Note: The LED of B/L is drive by current only, drive voltage is for reference only. drive voltage can make driving current under safety area (current between minimum and maximum).

### LED B\L Drive Method

#### 1. Drive from A , K

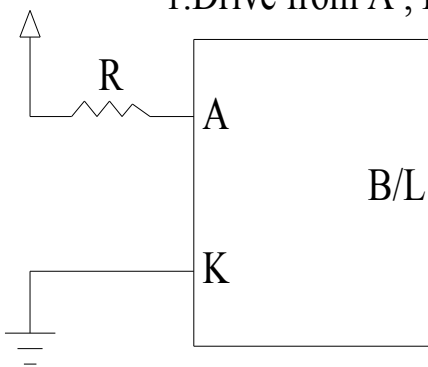

# 13. Material List of Components for RoHS

1. Crystalfontz America, Inc. hereby declares that all of or part of products (with the mark “#” in code), including, but not limited to, the LCM, accessories or packages, manufactured and/or delivered to your company (including your subsidiaries and affiliated company) directly or indirectly by our company (including our subsidiaries or affiliated companies) do not intentionally contain any of the substances listed in all applicable EU directives and regulations, including the following substances.

Exhibit A: The Harmful Material List

Material	(Cd)	(Pb)	(Hg)	(Cr6+)	PBBs	PBDEs
Limited Value	100 ppm	1000 ppm	1000 ppm	1000 ppm	1000 ppm	1000 ppm
Above limited value is set up according to RoHS.						

2. Process for RoHS requirement:

- (1) Use the Sn/Ag/Cu soldering surface: the surface of Pb-free solder is rougher than we used before.
- (2) Heat-resistance temp.:  
Reflow: 250°C, 30 seconds Max.  
Connector soldering wave or hand soldering: 320°C, 10 seconds max.
- (3) Temp. curve of reflow, max. Temp.: 235±5°C  
Recommended customer’s soldering temp. of connector: 280°C, 3 seconds.