



INTELLIGENT LCD MODULES  
DATA SHEET



Data Sheet Release Date 2015-03-30  
for the  
CFA632 Series

Hardware Version v3.3, Firmware Version v3.3

**Crystalfontz America, Incorporated**

12412 East Saltese Avenue  
Spokane Valley, WA 99216-0357

Phone: 888-206-9720

Fax: 509-892-1203

Email: [support@crystalfontz.com](mailto:support@crystalfontz.com)

URL: [www.crystalfontz.com](http://www.crystalfontz.com)



## NOTICES

### CFA632 Series Data Sheet Revision History

Data Sheet Release Date: 2015-03-30

- Wherever listed, changed firmware revision number from “v3.2” to “v3.3”. For details, see the notice under the Product Notices tab on web pages for all part numbers in this series.
- In command [Set Cursor Position \(Column and Row\) \(\017, 0x11, Control+Q\) \(Pg. 39\)](#), corrected second byte for the row from “(0-1)” to “(0-3)”.
- In command [Send Data Directly to the LCD Controller \(\030, 0x1E, Control+Equal\) \(Pg. 44\)](#), removed from table “\002 Control Register, (RS=0, RE=1)”. Also, the boxed note for this command was reworded to caution “*This command can disable or damage your display. Use this command at your own risk.*”
- Information in [Display Module Reliability \(Pg. 47\)](#) was updated.
- In Care And Handling Precautions sections, added a bullet under [Design and Mounting \(Pg. 48\)](#) about excessive external noise.
- In Demonstration Software section, for [632/634 Boot Screen Beta Version \(Pg. 50\)](#), added note “*For use only with display modules hardware v.2.4 and below.*”
- Wherever listed, updated descriptions of cable lengths.
- Wherever needed, made minor changes in terms to match current publication standards. For example, changed “family” to “series”. Changed “x” as a representative character in a part number to “\*”.

Data Sheet Release: 2014-02-25

- In Notices, added a statement that the CFA632 series has nonvolatile memory.
- In Current Consumption, improved graphs and tables, adding one for each color variant.
- In Module Outline Drawing, removed tolerance specification. Hardware has not changed.
- In first sentence in RS232 Power And Data Communications (CFA632-xxx-KSCFA634-xxx-KS), corrected from “PC’s 8-pin serial port” to “PC’s 9-pin serial port”.
- Clarified SPI interface description, including an improved graph. See SPI (CFA632-xxx-KPCFA634-xxx-KP).
- In the first paragraph of the section I2C (CFA632-xxx-KCCFA634-xxx-KC), a recommendation was added to include external pull-ups.
- Expanded explanations and included examples on how to use module configuration commands in Module Configuration (\009, 0x09, Control+I).
- Added command Large Block Number (\028, Control Backslash) back into the Data Sheet. This command was mistakenly omitted in the previous Data Sheet.
- In Care and Handling Precautions, added handling caution Modules Shipped In Trays.
- Updated and expanded information in APPENDIX A: FREE DEMONSTRATION AND DRIVER SOFTWARE.
- Wherever listed, updated length specification of cables.
- Minor changes in wording, graphics, and formatting to improve readability.

Data Sheet Release Date: 2013-07-15

- Added specifications for Current Consumption.
- Expanded specifications for LED BACKLIGHT CHARACTERISTICS.
- Slight adjustment to *Supply Voltage for Logic* Minimum specification in preliminary Data Sheet. See Recommended DC Characteristics).
- Removed “Preliminary” watermark from the Data Sheet.

Data Sheet Release Date: 2013-06-26

Complete Data Sheet rewrite. Information in previous individual variant Data Sheets were combined in this new series Data Sheet. New part numbers for modules with new interfaces were added. Discontinued modules CFA632-NFG-KS and CFA632-NFG-KU were omitted. All content was updated to reflect hardware version v3.3 and firmware version v3.2.

*This is a preliminary Data Sheet. The next Data Sheet will include current consumption specifications and backlight specifications.*



<b>CFA632 Series Data Sheet Revision History (Continued)</b>	
<p>2011-04-08 for <i>CFA632-YDI-KS</i>            and <i>CFA632-YFH-KS</i>            2011-04-14 for <i>CFA632-YDI-KU</i>            and <i>CFA632-YFH-KU</i></p>	<p>Current Data Sheet version: v1.3            Change: Wherever shown, corrected front illustration of the module. The PCB was shown rotated 180°. Dimensions have not changed.</p>
<p>2011-03-15</p>	<p>Data Sheet version: v1.2            Changes:</p> <ul style="list-style-type: none"> <li>● Improved illustrations by removing unnecessary components and adding better descriptions. See Module Outline Drawings and Jumper Locations and Functions. The module has not changed.</li> <li>● For <i>CFA632-YDI-KU</i> and <i>CFA632-YFH-KU</i>, added explanation for default information displayed on boot screen. See photo at the bottom of Features.</li> </ul>
<p>2011-02-24</p>	<p>Data Sheet version: v1.1            Changes:</p> <ul style="list-style-type: none"> <li>● Wherever listed, updated Hardware and Firmware revision numbers from “v2.2” to “v2.4”.</li> <li>● In Features, added “Factories have ISO certification”.</li> <li>● Added explanation of our part number system in Module Classification System.</li> <li>● In Physical Characteristics depth description, added note on specification to include DB9 connector and USB632634 interface board (for <i>CFA632-YDI-KS</i> and <i>CFA632-YFH-KS</i> only). DB9 is disabled for <i>CFA632-YDI-KU</i> and <i>CFA632-YFH-KU</i>.</li> <li>● In Module Outline Drawings and Jumper Locations and Functions, updated illustration of PCB back to show minor change in component layout and silkscreen.</li> <li>● In Set Scrolling Marquee Characters (\021, Control+U), corrected from “<i>index</i> determines which of the 20 scrolling marquee characters...” to “<i>index</i> determines which of the 16 scrolling marquee characters...” The number of characters has not changed.</li> <li>● Reorganized Data Sheet content in a more logical order.</li> </ul>
<p>2011-01-11</p>	<p>Data Sheet version: v1.0            First Data Sheet.</p>

**Hardware and Firmware Revisions**

For information about firmware and hardware revisions for the this series of intelligent LCD modules, see Part Change Notifications (PCNs) under the Notices tab on the website page for each CFA632 part number.



### About Variations

We work continuously to improve our products. Because display technologies are quickly evolving, these products may have component or process changes. Slight variations (for example, contrast, color, or intensity) between lots are normal. If you need the highest consistency, whenever possible, order and arrange delivery for your production runs at one time so your displays will be from the same lot.

### About Volatility

The CFA632 series of Crystalfontz Intelligent LCD Modules have nonvolatile memory.

### Additional Fine Print

Certain applications using Crystalfontz America, Inc. products may involve potential risks of death, personal injury, or severe property or environmental damage ("Critical Applications"). CRYSTALFONTZ AMERICA, INC. PRODUCTS ARE NOT DESIGNED, INTENDED, AUTHORIZED, OR WARRANTED TO BE SUITABLE FOR USE IN LIFE-SUPPORT APPLICATIONS, DEVICES OR SYSTEMS OR OTHER CRITICAL APPLICATIONS. Inclusion of Crystalfontz America, Inc. products in such applications is understood to be fully at the risk of the customer. In order to minimize risks associated with customer applications, adequate design and operating safeguards should be provided by the customer to minimize inherent or procedural hazard. Please contact us if you have any questions concerning potential risk applications.

Crystalfontz America, Inc. assumes no liability for applications assistance, customer product design, software performance, or infringements of patents or services described herein. Nor does Crystalfontz America, Inc. warrant or represent that any license, either express or implied, is granted under any patent right, copyright, or other intellectual property right of Crystalfontz America, Inc. covering or relating to any combination, machine, or process in which our products or services might be or are used.

All specifications in Data Sheets and on our website are, to the best of our knowledge, accurate but not guaranteed. Corrections to specifications are made as any inaccuracies are discovered.

Company and product names mentioned in this publication are trademarks or registered trademarks of their respective owners.

Copyright © 2015 by Crystalfontz America, Inc., 12412 East Saltese Avenue, Spokane Valley, WA 99216-0357 U.S.A



# CONTENTS

Notices	2
<b>INTRODUCTION</b>	<b>8</b>
Configuration Choices	8
Choose From Twelve Configurations	8
Customize Any Of The Twelve Configurations	9
How Part Number Configurations Are Described In This Data Sheet	9
Explanation Of Part Number Codes	10
Main Features	11
Comparison Of The Four Color (Variant) Choices	11
Kits And Accessories (Modules, Brackets, Overlays, And Cables)	12
<b>MECHANICAL SPECIFICATIONS</b>	<b>13</b>
Physical Characteristics	13
Module Outline Drawing	14
<b>ELECTRICAL SPECIFICATIONS</b>	<b>15</b>
System Block Diagram	15
LCD Duty And Bias	15
Absolute Maximum Ratings	16
Recommended DC Characteristics	16
Current Consumption	17
CFA632-YDI-K*	17
CFA632-YFH-K*	18
ESD (Electro-Static Discharge) Specifications	19
<b>LED BACKLIGHT CHARACTERISTICS</b>	<b>19</b>
<b>OPTICAL CHARACTERISTICS</b>	<b>20</b>
Optical Characteristics Specifications	20
Optical Characteristics Test Conditions And Definitions	20
Definition Of Optimal Contrast Setting	21
Definition Of Response Time (Tr, Tf)	22
Definition Of 6 O'Clock And 12:00 O'Clock Viewing Angles	23
Definition Of Vertical And Horizontal Viewing Angles (CR <sub>≥</sub> 2)	23
<b>INTERFACE CONNECTION INFORMATION</b>	<b>24</b>
Display Module Part Numbers For Default Interfaces	24
How To Reset Any Module's Interface To USB	24
USB Power And Data Communications (CFA632-***-KU)	25
RS232 Power And Data Communications (CFA632-***-KS)	26
LL - Logic Level (CFA632-***-KL) and LLI - Logic Level, Inverted (CFA632-***-KN)	27
SPI (CFA632-***-KP)	29
I2C (CFA632-***-KC)	31
Location and Description of Jumpers To Change Interface Type	32
Alternate Method To Power the Backlight For Non-USB Interfaces	34
<b>HOST COMMUNICATIONS</b>	<b>35</b>
About Handshaking	35
Control Codes And Their Functions	35
Description Of Control Functions	36



## CONTENTS, CONTINUED

Cursor Home (\001, 0x01, Control+A) -----	36
Hide Display (\002, 0x02, Control+B) -----	36
Show Display (\003, 0x03, Control+C) -----	36
Hide Cursor (\004, 0x04, Control+D) -----	37
Show Underline Cursor (\005, 0x05, Control+E) -----	37
Show Blinking Block Cursor with Underscore (\006, 0x06, Control+F) -----	37
Backspace (\008, 0x08, Control+H) -----	37
Module Configuration (\009, 0x09, Control+I) -----	37
Line Feed (\010, 0x0A, Control+J or Control+Enter) -----	38
Delete In Place (\011, 0x0B, Control+K) -----	39
Form Feed (\012, 0x0C, Control+L) -----	39
Carriage Return (\013, 0x0D, Control+M) -----	39
Backlight Control (\014, 0x0E, Control+N) -----	39
Contrast Control (\015, 0x0F, Control+O) -----	39
Set Cursor Position (Column and Row) (\017, 0x11, Control+Q) -----	39
Horizontal Bar Graph (\018, 0x18, Control+R) -----	39
Scroll ON (\019, 0x13, Control+S) -----	41
Scroll OFF (\020, Control+T) -----	41
Wrap ON (\023, 0x17, Control+W) -----	41
Wrap OFF (\024, 0x18, Control+X) -----	41
Set Custom Character Bitmap (\025, 0x19, Control+Y) -----	41
Reboot (\026, 0x1A, Control+Z) -----	42
Escape Sequence Prefix (\027, 0x1B, Escape) -----	43
Escape Sequence Prefix (\027, 0x1B, Escape) -----	43
Large Block Number (\028, Control Backslash) -----	43
Send Data Directly to the LCD Controller (\030, 0x1E, Control+Equal) -----	44
Show Information Screen (\031, 0x1F, Control+Minus) -----	44
<b>CHARACTER GENERATOR ROM (CGROM) -----</b>	<b>45</b>
<b>DISPLAY MODULE RELIABILITY AND LONGEVITY -----</b>	<b>47</b>
Display Module Reliability -----	47
Display Module Longevity (EOL / Replacement Policy) -----	47
<b>CARE AND HANDLING PRECAUTIONS -----</b>	<b>47</b>
<b>APPENDIX A: FREE DEMONSTRATION AND DRIVER SOFTWARE-----</b>	<b>50</b>
Demonstration Software -----	50
cfTest -----	50
CrystalControl2 (CC2) -----	50
Linux_CLI_Examples -----	50
BasicStamp2 -----	50
632/634 Boot Screen Beta Version -----	50
Drivers -----	50
Linux Driver -----	50
USB LCD Driver -----	51
<b>APPENDIX B: QUALITY ASSURANCE STANDARDS-----</b>	<b>52</b>



## LIST OF FIGURES

Figure 1. Example Of Bracket And Overlay-----	12
Figure 2. Module Outline Drawing -----	14
Figure 3. System Block Diagram -----	15
Figure 4. Definition Of Optimal Contrast Setting (Negative Image) -----	21
Figure 5. Definition Of Optimal Contrast Setting (Positive Image) -----	21
Figure 6. Definition Of Response Time (Tr, Tf) (Negative Image) -----	22
Figure 7. Definition Of Response Time (Tr, Tf) (Positive Image) -----	22
Figure 8. Definition Of 6:00 O'clock And 12:00 O'Clock Viewing Angles -----	23
Figure 9. Definition Of Horizontal And Vertical Viewing Angles (CR>2) -----	23
Figure 10. Location Of JPDFLT Pins To Reset Interface To USB -----	25
Figure 11. USB Connector Pins Labeled -----	25
Figure 12. Non-Backlight Operation Through 9-Pin Serial Port DB9 -----	27
Figure 13. Location Of J2 7-Pin Expansion Port For LL Or LLi Interface -----	28
Figure 14. Location Of JPWR Expansion Port-----	28
Figure 15. SPI Timing Diagram -----	30
Figure 16. Location Of J_I2C 4-Pin Expansion Port For I <sup>2</sup> C Interface -----	31
Figure 17. Jumper Locations On Back of PCB -----	32
Figure 18. Character Generator ROM (CGROM) -----	45





# INTRODUCTION

## CONFIGURATION CHOICES

### Choose From Twelve Configurations

If you already know what interface you need, you can buy CFA632 modules shipped with any of the six interfaces ready to use. You also have a choice of two colors. Twelve part numbers represent the different combinations of interfaces and colors.

		PART NUMBERS	
Variant Color		 YDI	 YFH
INTERFACE	USB 19200 baud equivalent throughput	CFA632-YDI-KU	CFA632-YFH-KU
	RS232 "full swing" RS232 serial 115200/19200 (default)/9600/4800/2400 baud rate	CFA632-YDI-KS	CFA632-YFH-KS
	LL logic level serial 0v to +5v	CFA632-YDI-KL	CFA632-YFH-KL
	LLi logic level serial, inverted +5v to 0v	CFA632-YDI-KN	CFA632-YFH-KN
	I <sup>2</sup> C	CFA632-YDI-KC	CFA632-YFH-KC
	SPI	CFA632-YDI-KP	CFA632-YFH-KP







## Customize Any Of The Twelve Configurations

These twelve configurations can be customized to include different connectors and cables. When you customize any one of the twelve configurations using the *Customize and Add to Cart* feature on a CFA632 product's web page, a unique part number is generated by adding characters to the end of the part number. For example, for the *CFA632-YDI-KL*, you may choose to customize by adding a 7-pin header. The part number in your shopping cart will be *CFA632-YDI-KL4*.

As a result of customizing and [kit configurator](#) choices, we offer over 46 configurations within the CFA632 series.

## How Part Number Configurations Are Described In This Data Sheet

For brevity, this Data Sheet uses the following part number naming conventions:

<b>x = Any Interface</b>	
CFA632-YDI-K*	CFA632-YFH-K*
	

<b>*** = Either Variant Color</b>	
CFA632-***-KC	I <sup>2</sup> C
CFA632-***-KL	Logic Level Serial
CFA632-***-KN	Logic Level Serial, Inverted
CFA632-***-KP	SPI
CFA632-***-KS	“Full Swing” RS232 Serial
CFA632-***-KU	USB



## EXPLANATION OF PART NUMBER CODES

<u>CFA</u>	<u>632</u>	-	<u>Y</u>	<u>*</u>	<u>*</u>	-	<u>K</u>	<u>*</u>	<u>*</u>
①	②		③	④	⑤		⑥	⑦	⑧



①	<b>Brand</b>	Crystalfontz America, Inc.
②	<b>Module Identifier</b>	632
③	<b>Backlight Type and Color</b>	Y – LED, yellow-green
④	<b>Fluid Type, Image (positive or negative), and LCD Glass Color</b>	* = D – FFSTN, negative, black F – FSTN, positive, neutral
⑤	<b>Polarizer Film Type, Operating Temperature Range<sup>1</sup>, and Viewing Angle (O ‘Clock)<sup>2</sup></b>	* = I – Transmissive, Wide Temperature Range, 6:00 H – Transflective, Wide Temperature Range, 6:00
<p><sup>1</sup>Wide Temperature operating range for these display modules is -20°C minimum to +70°C maximum.</p> <p><sup>2</sup>For more information on Viewing Angle, see <a href="#">Definition Of Vertical And Horizontal Viewing Angles (CR&gt;2) (Pg. 23)</a>.</p>		
⑥	<b>Special Code</b>	K – Manufacturer’s code
⑦	<b>Interface Code</b>	* = C – I <sup>2</sup> C P – SPI L – LL (logic level serial) N – LLi (logic level serial, inverted) S – “full swing” RS232 serial U – USB
⑧	<b>Customize<sup>3</sup></b>	* = 1 or more characters.
<p><sup>3</sup>When you customize any one of the twelve products using the Customize and Add to Cart feature on a web page, a unique part number is generated by adding one or more characters to the end of the part number.</p> <p>Display modules customized by adding accessories using the Kit Configurator also have unique part numbers. See <a href="#">Kits And Accessories (Modules, Brackets, Overlays, And Cables) (Pg. 12)</a>.</p>		



## MAIN FEATURES

- ❑ Large easy-to-read LCD in a compact size can display 16 characters x 2 lines. Overall module size is 108.00 mm width x 42.00 mm height x 19.90 mm depth (4.25" x 1.65" x 0.78"). Character height is 7.30 mm (0.29").
- ❑ Attractive stainless steel bezel.
- ❑ Optional [PC CDROM mounting bracket](#) with three choices of overlay to fit a single 5.25" wide bay is available. See [Kits And Accessories \(Modules, Brackets, Overlays, And Cables\) \(Pg. 12\)](#).
- ❑ The CFA632 series has two color (variant) choices:
  - **CFA632-YDI-K\***: Yellow-green array LED backlight with negative FFSTN transmissive mode LCD. Displays yellow-green characters on a dark (near-black) background. The display can be read in normal office lighting and in dark areas. May be difficult to read in direct sunlight.
  - **CFA632-YFH-K\***: Yellow-green array LED backlight with positive FSTN transreflective mode LCD. Displays dark (near-black) characters on yellow-green background. The display can be read in normal office lighting, in dark areas, and in bright sunlight.
- ❑ Use any of six interfaces on any module in the CFA632 series by changing the interface selection in a command and using the appropriate jumper configurations. See [INTERFACE CONNECTION INFORMATION \(Pg. 24\)](#).
- ❑ The displays have a 6 o'clock viewing angle (polarizer viewing direction). See [Definition Of Vertical And Horizontal Viewing Angles \(CR>2\) \(Pg. 23\)](#).
- ❑ Adjustable contrast. The module's default contrast value will be acceptable for many applications. If necessary, you can adjust the contrast by using control function [Contrast Control \(015, 0x0F, Control+O\) \(Pg. 39\)](#).
- ❑ The modules have a RockWorks RW1067 or compatible controller.
- ❑ Robust packet based communications protocol with 16-bit CRC.
- ❑ Extended voltage (9-15 volts for interfaces using DB9 connector) and 5 volts power inputs for the controller. Backlight is 5 volts.
- ❑ Use the nonvolatile memory capability (EEPROM) to customize the "power-on" display settings.
- ❑ Temperature range for operation is -20°C to +70°C.
- ❑ RoHS compliant. You can download the *Certificate of Compliance for ISO, RoHS, and REACH* from the Datasheets & Files tab on any CFA632 part number's website page. CrystalFontz American and the factory are ISO certified.

## COMPARISON OF THE COLOR (VARIANT) CHOICES

Part Number	 <b>CFA632-YDI-K*</b>	 <b>CFA632-YFH-K*</b>
<b>Fluid</b>	FFSTN	FSTN
<b>LCD Glass Color</b>	black	neutral
<b>Image</b>	negative	positive
<b>Polarizer Film</b>	transmissive	transflective
<b>LED Backlight</b>	yellow-green	
<i>FSTN has better contrast than STN. FFSTN has better contrast than FSTN.</i>		
<i>Positive Image: Sunlight readable and also readable in dark areas. Negative Image: May be difficult to read in direct sunlight.</i>		



## KITS AND ACCESSORIES (MODULES, BRACKETS, OVERLAYS, AND CABLES)

In addition to using the “Customize and Add to Cart” feature to customize a display module with different cables and connectors on a website order, you can use the [Kit Configurator](#) to order kits for CFA632-\*\*\*-KS (“full swing” RS232 serial default interface) and CFA632-\*\*\*-KU (USB default interface) that include accessories.

Here is an explanation of kit part numbers:

<u>DB</u>	<u>632</u>	-	<u>**</u>	<u>***</u>	-	<u>K</u>	<u>*</u>	<u>*</u>
①	②		③	④			⑤	⑥

①	<b>[type]</b> DB – Optional PC CDROM mounting bracket, single bay, 5.25" wide.
②	<b>[series]</b> 632 – Part of 632 series
③	<b>[overlay]</b> An overlay for the front of bracket with a display window of clear thick hard-coated polycarbonate Lexan®. Choice of four overlays are: AL – Silver Aluminum BG – Beige Plastic BK – Black Plastic
④	<b>[variant]</b> Choice of two colors (variants): YDI – Yellow-green characters on dark (near-black) background YFH – Dark (near-black) characters on yellow-green background
⑤	<b>[default interface]</b> Two choices: S – “full swing” RS232 serial U – USB
⑥	<b>[additional parts in kit]</b> x = One or more cables.

Here is a photo of a CFA632 bracket with black overlay:



Figure 1. Example Of Bracket And Overlay



If you want a CFA632-\*\*\*-KC, CFA632-\*\*\*-KL, or CFA632-\*\*\*-KP module mounted on a bracket with an overlay, please contact Technical Support at [support@crystalfontz.com](mailto:support@crystalfontz.com) to receive a price quote for a special order kit.

You can also buy cables individually. See [INTERFACE CONNECTION INFORMATION \(Pg. 24\)](#) for descriptions of suggested cables for the various interfaces. Or see all of the cables on our website [here](#).

## MECHANICAL SPECIFICATIONS

---

### PHYSICAL CHARACTERISTICS

ITEM	SPECIFICATION
Pixels	
Pixel Size	Millimeters: 0.72 (W) x 0.86 (H) mm
Pixel Pitch	Millimeters: 0.78 (W) x 0.92 (H) mm
Active Area	Millimeters: 74.82 (W) x 15.80 (H) mm Inches: 2.95" (W) x 0.62" (H)
Viewing Area	Millimeters: 82.30 (W) x 22.50 (H) mm Inches: 3.24"(W) x 0.89" (H)
Character	
Character Pitch	Millimeters: 4.68 (W) x 8.50 (H) mm Inches: 0.18" (W) x 0.33"(H)
Character Size	Millimeters: 3.84 (W) x 7.30 (H) mm Inches: 0.15" (W) x 0.29" (H)
Module Overall Dimensions	
Width and Height	Millimeters: 108.00 (W) mm x 42.00 (H) mm Inches: 4.25" (W) mm x 1.65" (H) mm
Module Depth (Includes DB9 Connector)	Millimeters: 19.90 mm Inches: 0.78"
Weight	72 grams



# MODULE OUTLINE DRAWING

Figure 2. Module Outline Drawing

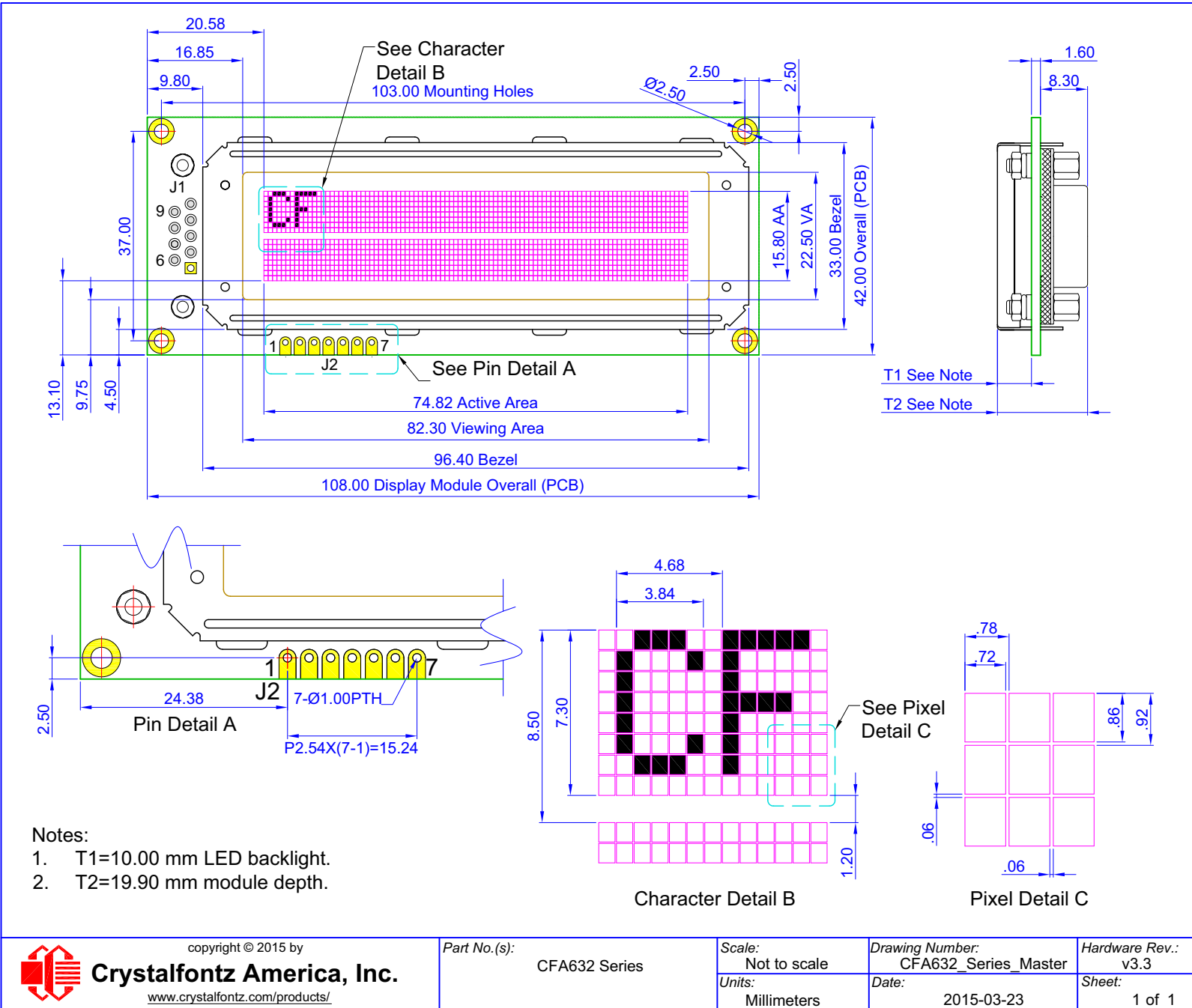



# ELECTRICAL SPECIFICATIONS

## SYSTEM BLOCK DIAGRAM

Use any of six interfaces on any of the modules in the series by simply changing the interface selection in a command and using the appropriate jumper configurations. See [INTERFACE CONNECTION INFORMATION \(Pg. 24\)](#) and [Module Configuration \(\009, 0x09, Control+I\) \(Pg. 37\)](#).

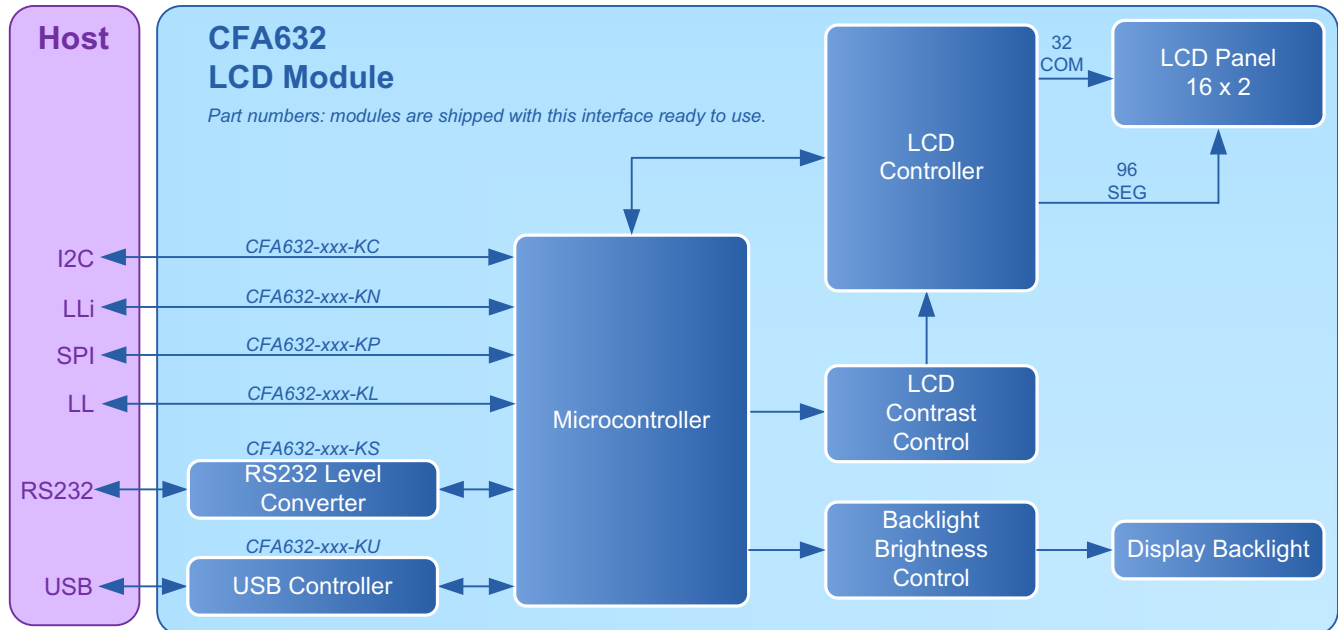

Figure 3. System Block Diagram

## LCD DUTY AND BIAS

DRIVING METHOD	SPECIFICATION
Duty <sup>1</sup>	1/32
Bias <sup>2</sup>	1/6.7

<sup>1</sup>The duty cycle, also known as duty ratio or multiplex rate, is the fraction of total frame time that each row of the LCD is addressed.

<sup>2</sup>The drive bias, also known as voltage margin, is related to the number of voltage levels used when driving the LCD. Bias is defined as 1/(number of voltage levels-1). The more segments driven by each driver(1), the higher number of voltage levels are required. There is a direct relationship between the bias and the duty.



## ABSOLUTE MAXIMUM RATINGS

ABSOLUTE MAXIMUM RATINGS	SYMBOL	MINIMUM	MAXIMUM
Operating Temperature	T <sub>OP</sub>	-20°C	+70°C
Storage Temperature	T <sub>ST</sub>	-30°C	+80°C
Humidity Range, Non-condensing	RH	10%	90%
Supply Voltage For Logic (See note below)	V <sub>DD</sub>	0	+5.25v
Input And Output Pins For RS232 Serial (CFA632-***-KS)			
RS232 Input Pin	V <sub>RX</sub>	-25v	+25v
RS232 Output Pin	V <sub>TX</sub>	-13v	+13v
<p><i>Note</i> These are stress ratings only. Extended exposure to the absolute maximum ratings listed above may affect device reliability or cause permanent damage. Functional operation of the module at these conditions beyond those listed under <a href="#">Recommended DC Characteristics (Pg. 16)</a> is not implied.</p> <p>Powering from pins 4 and 7 on DB9, maximum voltage rating is +15v. (See pin descriptions on <a href="#">Pg. 26</a>).</p> <p>Changes in temperature can result in changes in contrast.</p>			

## RECOMMENDED DC CHARACTERISTICS

RECOMMENDED DC CHARACTERISTICS	SYMBOL	MINIMUM	TYPICAL	MAXIMUM
Supply Voltage for Logic (+5v)	V <sub>DD</sub> -V <sub>O</sub>	+4.50v	+5.00v	+5.25v
Logic Input High Voltage	V <sub>IH</sub>	+2.1v	-	V <sub>DD</sub>
Logic Input Low Voltage	V <sub>IL</sub>	V <sub>SS</sub>	-	+0.08v
RS232 serial (for CFA632-***-KSCFA632-***-KS) supplied through DB9 connector using on-board regulator		±9v	-	±15v





## CURRENT CONSUMPTION

Current consumption varies by color (variant) choice. Current consumption is the same for all interfaces.

### CFA632-YDI-K\*

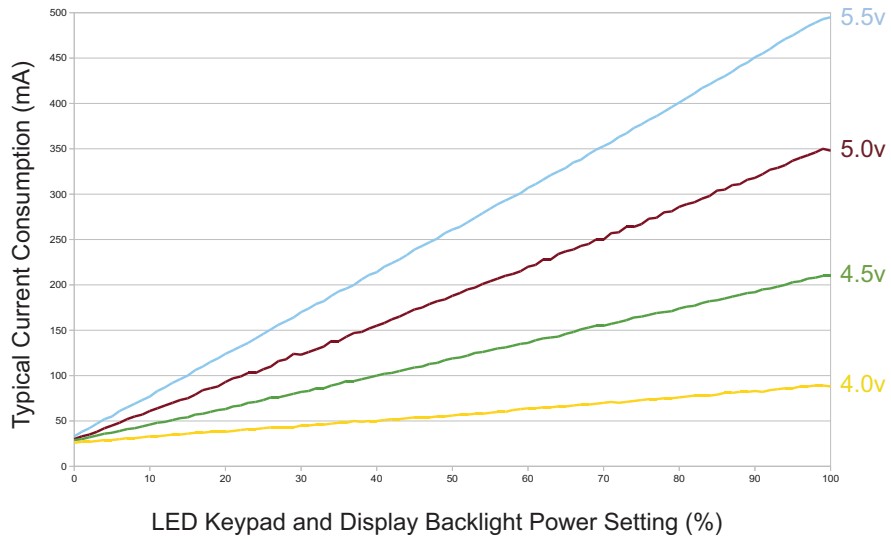

ITEMS ENABLED		TYPICAL CURRENT CONSUMPTION	
Logic	LCD Backlight	V <sub>DD</sub> = +4.5v	V <sub>DD</sub> = +5.0v
X	0%	TBD mA	TBD mA
X	100%	TBD mA	TBD mA



CFA632-YFH-K\*

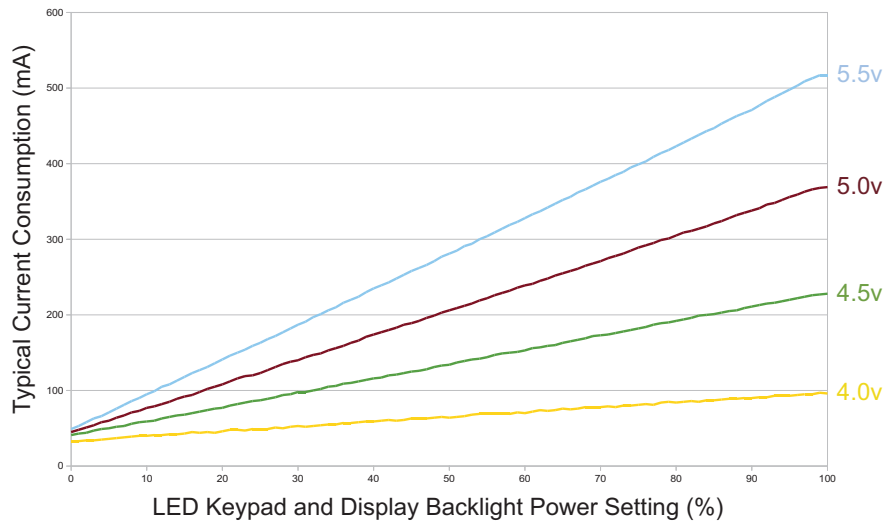

ITEMS ENABLED		TYPICAL CURRENT CONSUMPTION	
Logic	LCD Backlight	V <sub>DD</sub> = +4.5v	V <sub>DD</sub> = +5.0v
X	0%	TBD mA	TBD mA
X	100%	TBD mA	TBD mA



## ESD (ELECTRO-STATIC DISCHARGE) SPECIFICATIONS

The circuitry is industry standard CMOS logic and is susceptible to ESD damage. Please use industry standard anti-static precautions as you would for any other static sensitive devices such as expansion cards, motherboards, or integrated circuits. Ground your body, work surfaces, and equipment.

## LED BACKLIGHT CHARACTERISTICS

---

LED Backlight Characteristics For CFA632 Series Test Condition: Supply Voltage = $V_{DD}$		
ITEM	SYMBOL	TYPICAL
Luminous Intensity Through Panel		
CFA632-YDI-K*	IV	386 cd/m <sup>2</sup>
CFA632-YFH-K*	IV	347 cd/m <sup>2</sup>
Backlight PWM Frequency <sup>2</sup>		300 Hz nominal
<i><sup>2</sup>PWM is Pulse Width Modulation. PWM is a way to simulate intermediate levels by switching a level between full on and full off. PWM can be used to control the brightness of LED backlights, relying on the natural averaging done by the human eye, as well as for controlling fan power.</i>		



# OPTICAL CHARACTERISTICS

## OPTICAL CHARACTERISTICS SPECIFICATIONS

ITEM	SYMBOL	CONDITION	MINIMUM	TYPICAL	MAXIMUM
Viewing Angle, Horizontal	$\theta_{X+}$	CR $\geq$ 2 Viewing Angle: 25°	-15 degrees	—	45 degrees
	$\theta_{X-}$				
Viewing Angle, Vertical	$\theta_{Y+}$		-45 degrees	—	45 degrees
	$\theta_{Y-}$				
Contrast Ratio <sup>1</sup>	CR	3			
LCD Response Time <sup>2,3</sup>	T rise	Ta = 25°C		120 ms	240 ms
	T fall	Ta = 25°C		120 ms	120 ms
<sup>1</sup> Contrast Ratio = (brightness with pixels light)/(brightness with pixels dark). <sup>2</sup> Response Time: The amount of time it takes a liquid crystal cell to go from active to inactive or back again. <sup>3</sup> For reference only.					
Viewing Direction: 6 o'clock					

## OPTICAL CHARACTERISTICS TEST CONDITIONS AND DEFINITIONS

We work to continuously improve our products, including backlights that are brighter and last longer. Slight color variations from module to module and batch to batch are normal.

- Viewing Angle
  - Vertical (V) $\theta$ : 0°
  - Horizontal (H) $\phi$ : 0°
- Frame Frequency: 78 Hz
- Driving Waveform: 1/16 Duty, 1/13 Bias
- Ambient Temperature (Ta): 25°C



### Definition Of Optimal Contrast Setting

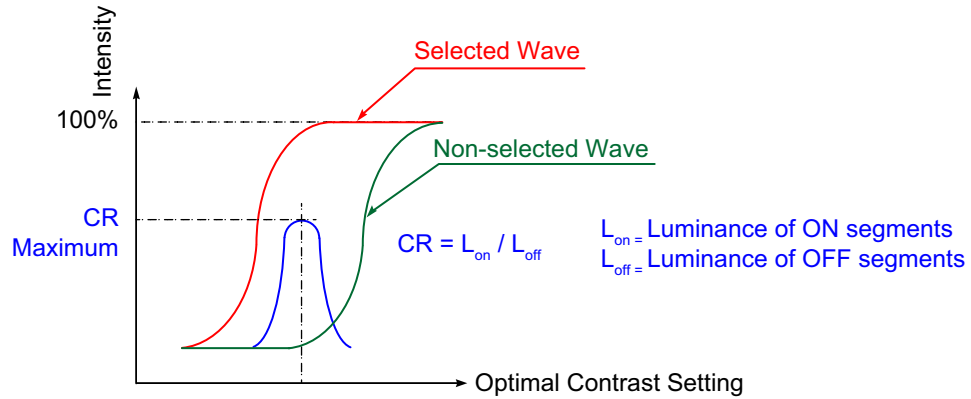

Figure 4. Definition Of Optimal Contrast Setting (Negative Image)

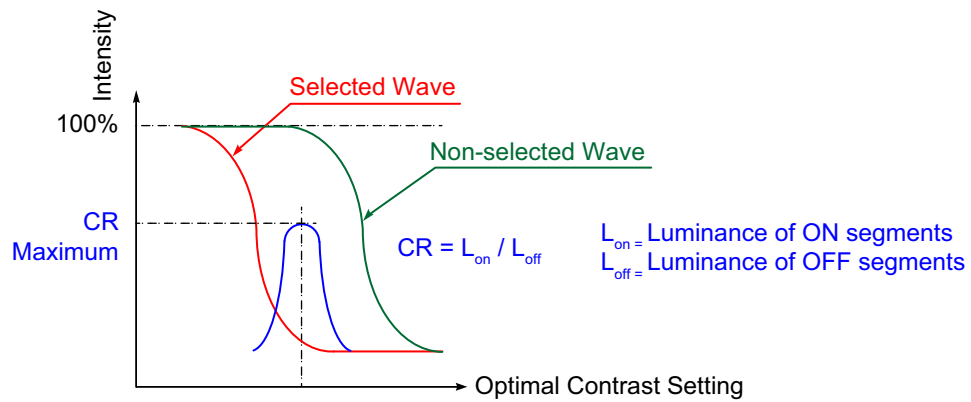

Figure 5. Definition Of Optimal Contrast Setting (Positive Image)



### Definition Of Response Time ( $T_r$ , $T_f$ )



CFA632-YDI-K\*

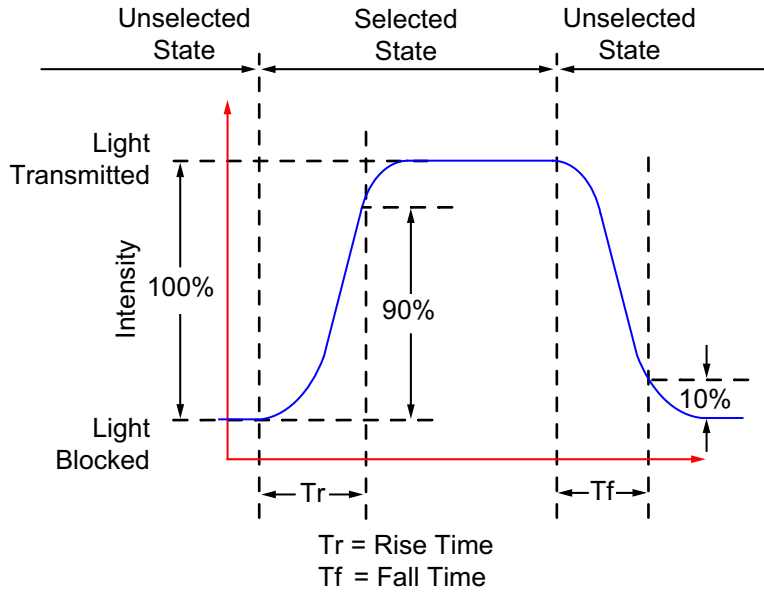

Figure 6. Definition Of Response Time ( $T_r$ ,  $T_f$ ) (Negative Image)



CFA632-YFH-K\*

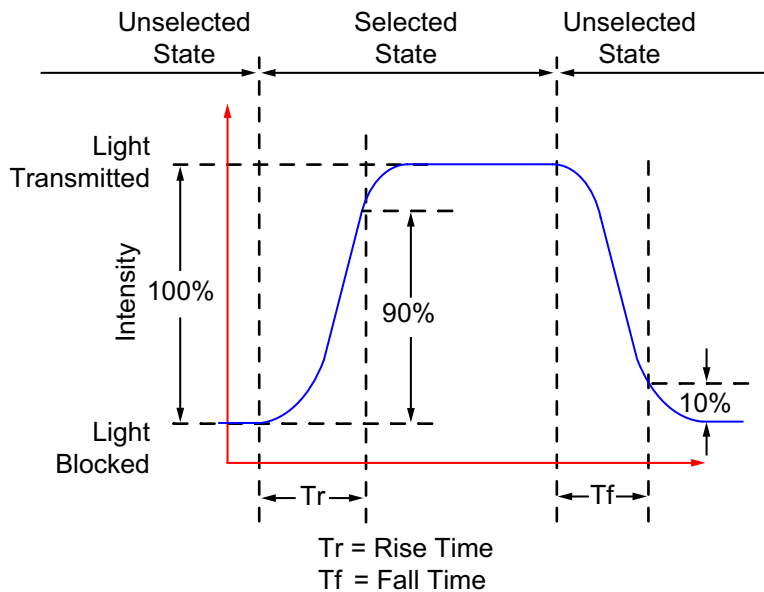

Figure 7. Definition Of Response Time ( $T_r$ ,  $T_f$ ) (Positive Image)



### Definition Of 6 O'Clock And 12:00 O'Clock Viewing Angles

This display module has a 6:00 o'clock viewing angle.

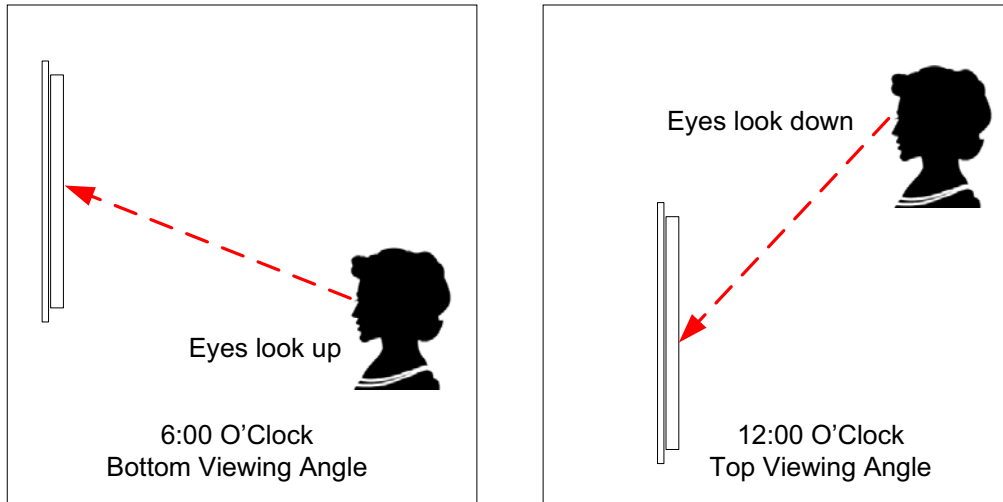

Figure 8. Definition Of 6:00 O'clock And 12:00 O'Clock Viewing Angles

### Definition Of Vertical And Horizontal Viewing Angles (CR<sub>≥</sub>2)

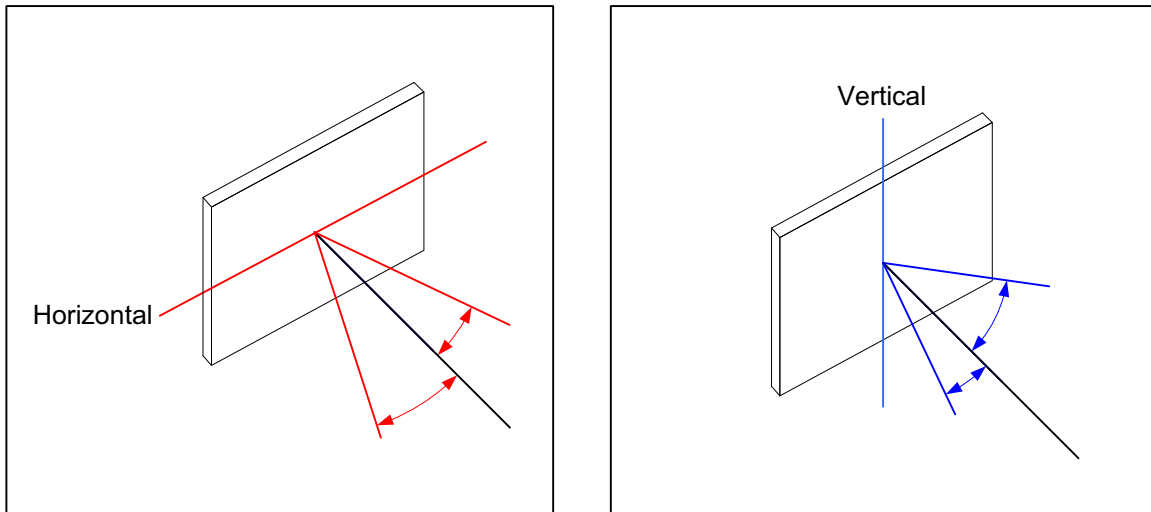

Figure 9. Definition Of Horizontal And Vertical Viewing Angles (CR<sub>≥</sub>2)



## INTERFACE CONNECTION INFORMATION

---

### DISPLAY MODULE PART NUMBERS FOR DEFAULT INTERFACES

The CFA632 series is shipped with the following configurations:

Part Number	Default Interface
CFA632-***-KC	I <sup>2</sup> C
CFA632-***-KL	Logic Level Serial
CFA632-***-KN	Logic Level Serial, Inverted
CFA632-***-KP	SPI
CFA632-***-KS	“Full Swing” RS232 Serial
CFA632-***-KC	USB

The hardware shipped with any of the configurations in the table above is identical.

To change the default interface for any of these display modules:

1. Change the interface selection setting using the control function [Module Configuration \(009, 0x09, Control+I\) \(Pg. 37\)](#).
2. Ensure the jumpers are in the correct position (see [Location and Description of Jumpers To Change Interface Type \(Pg. 32\)](#)).
3. Use the connection information below.

### HOW TO RESET ANY MODULE'S INTERFACE TO USB

If you aren't sure what your module's interface setting is, you can reset any display module to USB interface at 19200 kbps. Temporarily jumper (short) the two JPDFLT pins together while the display module is powered. The module will display the reset screen. Cycle power to reset to the module to USB.





Short JPDFLT pins to reset interface to USB.

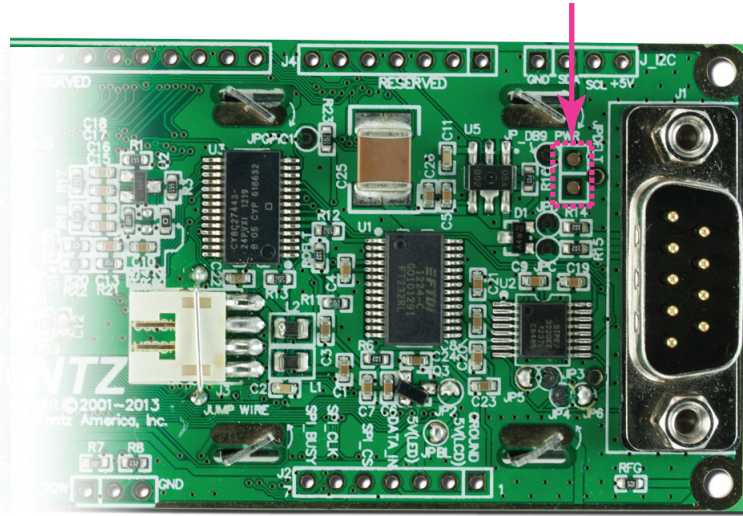

Figure 10. Location Of JPDFLT Pins To Reset Interface To USB

## USB POWER AND DATA COMMUNICATIONS (CFA632-\*\*\*-KU)

The USB interface requires only one connection to the host for both data communications and power supply. The module has a low profile 2 mm latching polarized connector for USB connection.

We offer three USB cables to connect between the display module and the host:

1. Use the [WR-USB-Y03](#) (~1.94 meter) to connect the cable's smaller 2 mm female USB connector to the display module's 2 mm male USB connector. Connect the cable's larger USB-A female connector to host's USB-A connector.
2. Use the [WR-USB-Y11](#) (~0.77 meter) to connect the cable's 2 mm female USB connector to the display module's 2 mm male USB connector. Connect the four single pin connectors directly onto the USB headers typically found on motherboards.
3. Use the [WR-USB-Y33](#) (~0.69 meter) to connect the cable's smaller 2 mm female USB connector to the display module's 2 mm male USB connector. Connect the cable's larger female 4-pin 0.1" connector to the USB pins on your host's motherboard

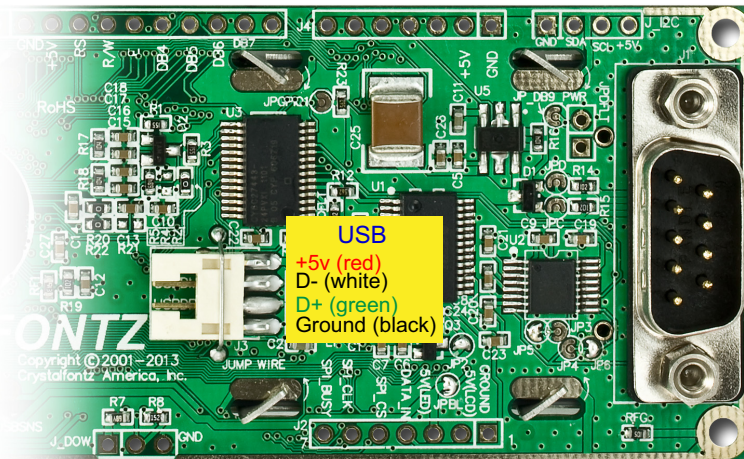
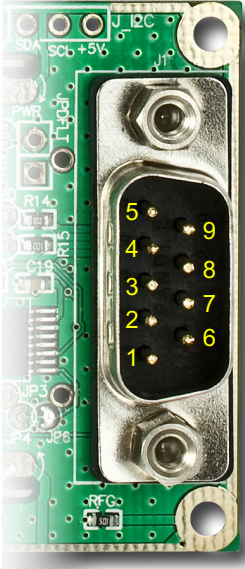

Figure 11. USB Connector Pins Labeled



## RS232 POWER AND DATA COMMUNICATIONS (CFA632-\*\*\*-KS)

The CFA632 has a male 9-pin DB9 connector that can connect to a PC's 9-pin serial port. Below is a view looking into the male DB9 connector (labeled J1):



PIN	DB9 DISPLAY FUNCTION	CORRESPONDING PC PIN NAME
1	Not Connected	DCD (Data Carrier Detect)
2	Not Connected	Rx (Receive Data)
3	Data In	Tx (Transmit Data)
4	Power A (9 volts to 15 volts)	DTR (Data Terminal Ready)
5	Ground (V <sub>SS</sub> )	Signal Ground
6	Connected to Power A if JPD is closed	DSR (Data Set Ready)
7	Power B (9 volts to 15 volts)	RTS (Request To Send)
8	Connected to Power B if JPC is closed	CTS (Clear To Send)
9	Not Connected	RI (Ring Indicator)

Most RS232 ports will be able to power the display module but not its backlight through their DTR and RTS lines. Have your software drive these lines high—most software already will. As of hardware v3.0, the module includes the ability to support, and change between, multiple interfaces as desired. This brought with it an increase in current consumption resulting in a greater need from the host device. To power the backlight in RS232 mode, refer to the alternate method for powering the backlight below.

### Non-Backlight Operation Through A PC's 9-Pin Serial Port

For non-backlight operation when the module is connected to a PC's 9-pin serial port, all you need is a "straight through" RS232 9-pin female to female DB9 cable. Connect one of the cable's RS232 female DB9 connectors to the DB9 male connector on the display module. Connect the cable's other RS232 female DB9 connector to the DB9 male connector on your PC.

Three DB9 cables lengths are available:

1. [WR-232-Y01](#) ~1.765m
2. [WR-232-Y04](#) ~2.9m
3. [WR-232-Y10](#) ~315mm

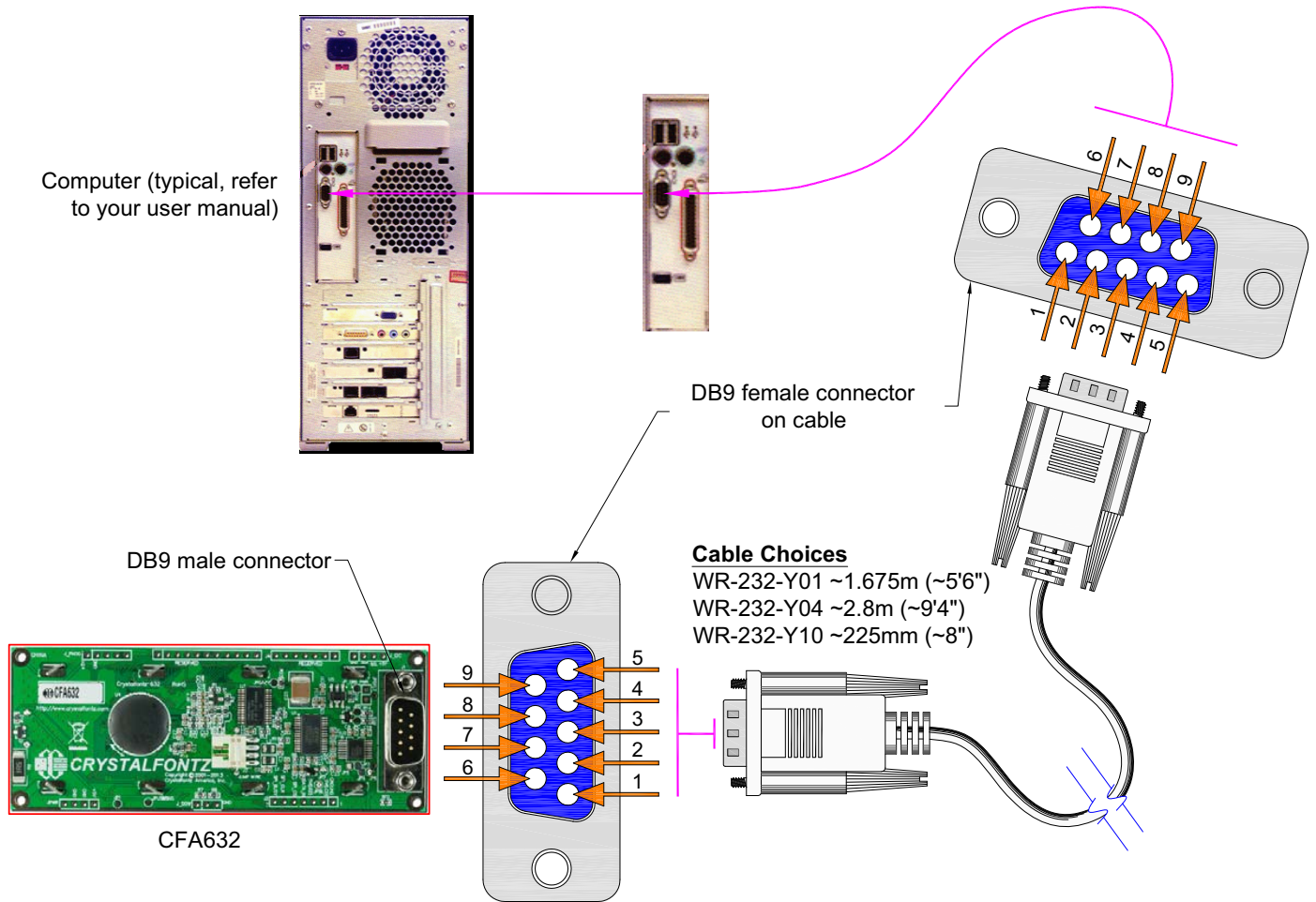

Figure 12. Non-Backlight Operation Through 9-Pin Serial Port DB9

To connect the display module with RS232 interface to a PC expansion slot, use a [WR-232-Y09](#) ribbon cable (~0.965 meter).

To connect a display module with RS232 to a motherboard with a 10-pin male connector with normal or alternate pinout, use a [WR-232-Y23](#) (~0.655 meter) cable.

The DB9 pin serial RS232 plus DC power connector allows you to bring serial connectivity and power to another device. A DB9 serial connection does not use all of its 9 pins in the interface with an RS232 cable. The [WR-232-Y18](#) cable (~2.8 meter) is designed to provide a power to supply piggy-back the cable so that the previously unused pins now provide 5V power.

## LL - LOGIC LEVEL (CFA632-\*\*\*-KL) AND LLI - LOGIC LEVEL, INVERTED (CFA632-\*\*\*-KN)

LL or LLI are useful when the display module is used with an embedded microcontroller's built-in UART. These UARTs typically output an inverted logic level (0-5 volts) version of the RS232 waveform. By setting the display module to accept LL or LLI data, you can connect this logic level signal directly to the display module and avoid the RS232 driver requirement.



To connect the display module to most embedded systems, you only need to use the display module's expansion port J2. The J2 expansion port has standard 0.1-inch (2.54 mm) spacing. Generally, you would connect a regulated 5 volt supply for the controller to +5V(LCD), GROUND to GROUND, and module's output to DATA\_IN. DATA\_IN will only accept 0 volt to 3.3 volt "CMOS" or 0 volt to 5 volt logic levels. If your data is inverted, which is a common configuration of a microcontroller "UART Tx" pin, you should configure the display module to use the LL or LLi interface.

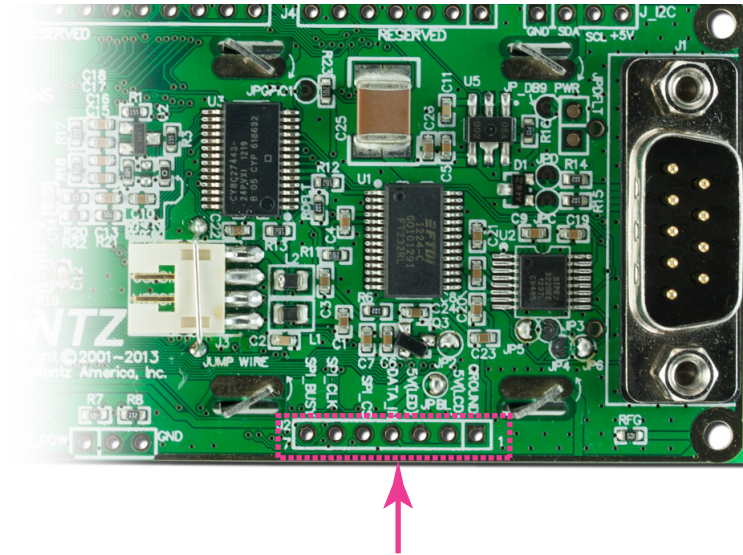

J2 7-Pin Expansion Port For LL Or LLi Interface

Figure 13. Location Of J2 7-Pin Expansion Port For LL Or LLi Interface

A possible J2 connector for LL or LLi communications is the [Digi-Key 7-pin Molex 22-23-2071](#).

### To Power The Display Module Using J2 Or JPWR Expansion Port Pins



JPWR Expansion Port

Figure 14. Location Of JPWR Expansion Port



The easiest place in a PC to get +5 volts is from a disk drive power connector. The red wire is typically 5 volts and the black wires are typically ground. The [WR-PWR-Y02](#) cable (~0.935 meter) or the [WR-PWR-Y12](#) cable (~320 millimeters) will connect from a spare power connector from your PC's power supply to the display module.

Note

If you make your own cable, be sure to measure the output voltage and polarity before you connect the display. Caution: some computers may have unconventional wire color assignments.

Note

Do not use the yellow wire of the disk drive power cable. This wire is typically the 12 volt supply and will ruin the display and/or backlight if it is connected instead of 5 volts.

A possible connector for JPWR expansion port is the 4-pin [Digi-Key Molex 22-23-2041](#).

## SPI (CFA632-\*\*\*-KP)

SPI up to 8 MHz is useful with embedded microprocessors that lack a hardware UART. On the host microprocessor, any three general-purpose output ports and a small "send byte" routine can be used to control the display. If the host microprocessor has a hardware SPI port, that can be used, provided that the port's speed can be set to satisfy the timing constraints. A software state-machine and a timer interrupt could also be used, this would reduce the microprocessor's load while still satisfying the timing requirements.

Another useful feature of SPI is that additional displays can be controlled with only one additional output port (SPI\_CS) per display. The other lines (SPI\_CLK and SPI\_DATA) are common. When in SPI mode, the display module will display "SPI" instead of the baud rate on the information screen. (See [Show Information Screen \(\031, 0x1F, Control+Minus\) \(Pg. 44\)](#)).

The display module has a 64-character input buffer. For the RS232 interface, it is nearly impossible to overflow this buffer since the display can process commands more quickly than the 115200-baud RS232 interface can deliver them, so normally no flow control is needed. The exceptions are the routines that access the EEPROM (the \009 series) and a rare combination of commands that take a long time to execute, followed by a burst of characters that is larger than the input buffer.

If your processor can deliver data through the SPI interface at a rate faster than 1000 bytes/second, then the processor should make sure the MISO line is "low" before sending a new command. The MISO line will be held "high" by the display module when there are 32 or more characters in the display module's input buffer, and released when there are less than 32 characters.

The SPI interface option allows the display module to communicate over the standard 4-wire SPI lines (SCLK, MOSI, MISO, and SS). Its clock is controlled by the master and is therefore able to communicate at any of the multitude of standard SPI data rates. The SPI interface uses *Mode 3* communication in the MSB configuration. Multiple slaves can be connected together using the master's slave select.



The display module uses *Mode 3* in the diagram below.

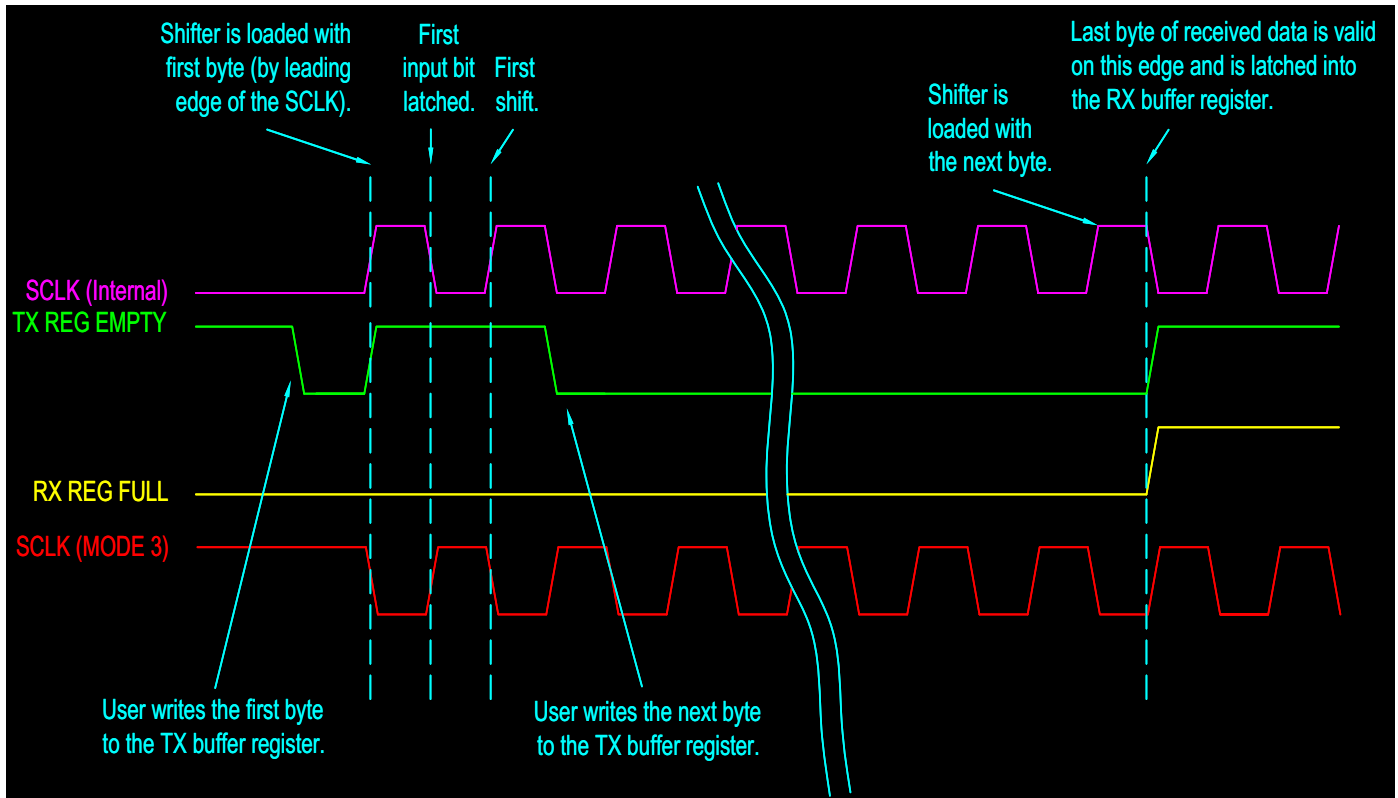

Figure 15. SPI Timing Diagram

- $\overline{\text{SPI\_CS}}$  must be low before  $\overline{\text{SPI\_CLK}}$  falls.
- $\overline{\text{SPI\_CS}}$  must stay low for the entire transfer.
- $\text{SPI\_DATA}$  must be correct before  $\overline{\text{SPI\_CLK}}$  falls.
- $\text{SPI\_DATA}$  must be held for a minimum of  $50\mu\text{s}$  after  $\overline{\text{SPI\_CLK}}$  falls.
- The maximum clock rate is  $1/55\mu\text{s}$  or  $1/125\text{ ns}$  or 8 MHz.
- Data is transferred MSB first; two out of eight cycles are shown.



- CPOL = 1, CPHA = 1 for most processors.
- Take SPI\_CS high for a minimum of 55 $\mu$ s to guarantee bit synchronization.
- Maximum throughput is  $1/(9 \times 55) = 2020$  bytes / second.

## I2C (CFA632-\*\*\*-KC)

The I<sup>2</sup>C interface option allows the display module to operate in slave mode supporting the 100 kbps original and 400 kbps fast mode communication speeds. Benefits to using I<sup>2</sup>C are: only two data/bus lines are required, no strict clocking to confine your environment, and a simple master/slave relationship with multi-device support utilizing a software-configurable address. The CFA632-\*\*\*-KC has internal pull-ups of 40 k $\Omega$  to 80 k $\Omega$  that may not be sufficient in all circumstances. We recommend that you include external pull-ups as appropriate to your application.

A possible connector for I<sup>2</sup>C expansion port is the 4-pin [Digi-Key Molex 22-23-2041](#) loaded at J\_I2C. This will also allow the module to be powered using that header, if desired.

The display module ships by default with an I<sup>2</sup>C address of 42<sub>10</sub>. The I<sup>2</sup>C protocol specifies each module with two addresses. The first 7 bits of both addresses are the same, in this case 00101010<sub>2</sub>. The address is then left bit-shifted with a read bit (1) or write bit(0). If a master device wishes to *write* to the display module, it would transmit 01010100<sub>2</sub> which is 42<sub>10</sub> left bit-shifted with a 0 (84<sub>10</sub>). If instead a master device wishes to *read* from the display module, it would transmit 01010101<sub>2</sub> which is 42 left bit-shifted with a 1 (85<sub>10</sub>).

### Note

Each command byte and all applicable data bytes must be transmitted as a single “packet” in order to be processed correctly.

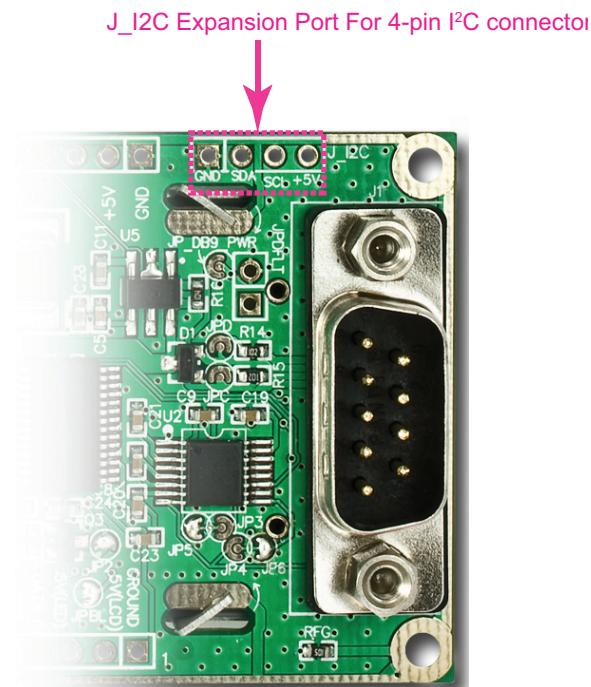

Figure 16. Location Of J\_I2C 4-Pin Expansion Port For I<sup>2</sup>C Interface



## LOCATION AND DESCRIPTION OF JUMPERS TO CHANGE INTERFACE TYPE

The display module's PCB has twelve jumpers. Ten of the twelve jumpers can be changed. See the jumper table on the next page for details.

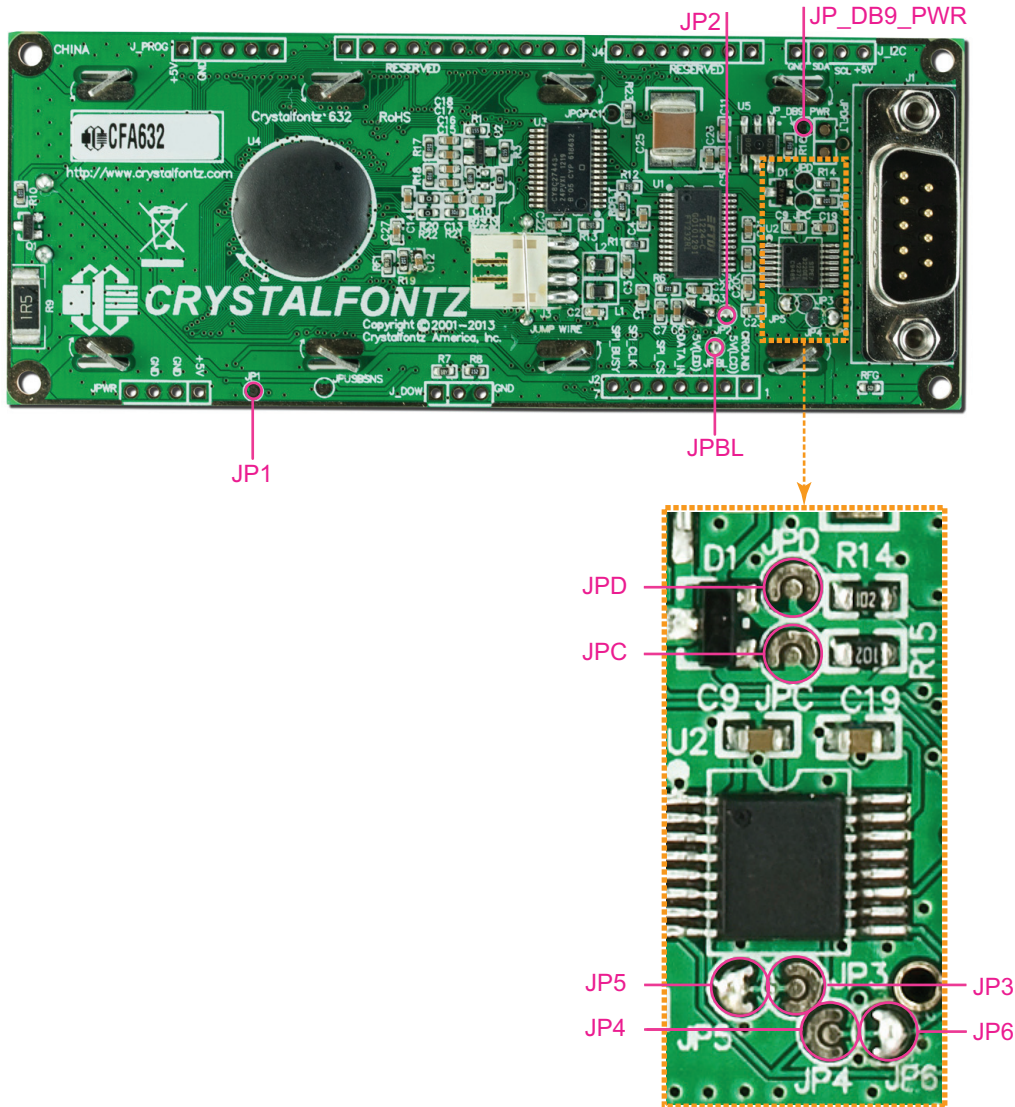

Figure 17. Jumper Locations On Back of PCB





To change interface type on a module, you may need to open or close certain jumpers. To close a jumper, melt solder across the gap. To open a jumper, remove the solder. Solder wick works well for this.

<i>Do not change factory setting on JPGPIO1 and JPUSBSNS.</i>						
JUMPERS THAT CAN BE CHANGED	SPECIFICATION  O Jumper open C Jumper closed – Jumper open or closed has no effect	USB	RS232	LL/LLI	I <sup>2</sup> C	SPI
		JP3, JP4	<i>Open:</i> DATA_IN is RS232 (-10v to +10v swing). <i>Closed:</i> DATA_IN is 0v to +5v swing.	–	O	C
JP5, JP6	<i>Open:</i> DATA_IN is 0v to +5v swing. <i>Closed:</i> DATA_IN is RS232 (-10v to +10v swing).	–	C	O	O	O
JPC, JPD	Some host hardware or software may require the display to assert its DSR and/or CTS lines before it will send data to the display. <i>Open:</i> JPC – DSR is open. JPD – CTS is open. <i>Closed:</i> JPC – DTR is fed back on DSR through 1K Ω resistor. JPD – RTS is fed back on CTS through 1K Ω resistor.	–	O/C	–	–	–
JP2	<i>Open:</i> Disconnects USB's +5v power line from display module's +5v power plane. <i>Closed:</i> Connects USB's +5v power line to display module's +5v power plane.	C	O	–	–	–
FOR ALL INTERFACES						
JPBL	<i>Open:</i> Use separate supply for logic and backlight. <i>Closed:</i> Connects +5v LCD line to display module's +5v power plane to power the backlight from the same supply as the logic.					
JP_DB9_PWR	<i>Open:</i> Disconnects DB9 Pins 7 and 8 from the display module's power plane. <i>Closed:</i> Connects DB9 Pins 7 and/or 8 directly to the display module's +5v power plane. <b>Closing this jumper and connecting the module via the DB9 connector may put voltage in excess of +6v to the module and damage it beyond repair.</b>					
JP1	<i>Open:</i> Disconnects the JPWR header from the display module's +5v power plane. <i>Closed:</i> Connects the JPWR header to the display module's +5v power plane. <i>Note:</i> JPWR's +5v pin is always connected to the PsoC.					
JPGPIO1	Reserved.					
JPUSBSNS	Reserved.					
<i>*Frameground is a trace connecting the mounting holes, bezel, and shell of the DB9.</i>						



## ALTERNATE METHOD TO POWER THE BACKLIGHT FOR NON-USB INTERFACES

The display module's backlight brightness is controlled by PWM (Pulse Width Modulation). The PWM may cause noise on supplies that have high output impedance. Noise from the backlight PWM can cause problems in your application. You may want to connect a filter capacitor from +5V(LCD) to GROUND close to the display. You can also operate the backlight at full brightness which disables the PWM.

To use the backlight in any of the following configurations requires a regulated +5 volt supply capable of sourcing 400 mA, hereby referred to as the supply. The supply can connect to any +5V(LED) terminal. This may be the same supply that is used for +5V(LCD).

Note  
Do not connect a supply greater than 5.25 volts to V<sub>DD</sub> or 5v(LED). **If you do, you will damage the display module.**

### To Power The Backlight Using J2 Expansion Port Pins

To power the backlight, connect the supply to pin 3 labeled +5v(LED) on the J2 connector. The supply's ground should connect to the V<sub>DD</sub> terminal of J2 labeled GROUND, shown below.

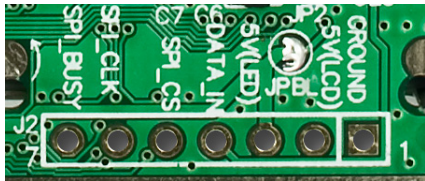

PIN	PIN NAME	FUNCTION
1	GROUND	Ground (backlight and controller)
2	+5V(LCD)	Controller and LCD power (+5 volts only)
3	+5V(LED)	LED Backlight power (+5 volts only)
4	DATA_IN	Serial data in (input)
5	$\overline{\text{SPI\_CS}}$	SPI Chip Select (active low input)
6	SPI_CLK	SPI Clock (input)
7	SPI_BUSY	SPI Busy (for status output)



## HOST COMMUNICATIONS

Note for RS232 serial interface (CFA632-\*\*\*-KS): The baud rate is set in the firmware. In previous versions of this module, the baud rate was set with dip switches. See interface selection choices in the table in [Module Configuration \(\009, 0x09, Control+I\) \(Pg. 37\)](#).

### ABOUT HANDSHAKING

- ❑ The display can generally execute commands faster than the interface can deliver them so no handshaking is necessary from the display's point of view. The few exceptions involve accessing the EEPROM (For example, see [Module Configuration \(\009, 0x09, Control+I\) \(Pg. 37\)](#)).
- ❑ For RS232 serial interface (CFA632-\*\*\*-KS), some host hardware or software may require the display to assert its DSR and/or CTS lines before it will send data to the display. In that case, JPC and/or JPD may be closed. Closing JPC will connect DSR to DTR through a 1K  $\Omega$  resistor. Closing JPD will connect CTS to RTS through a 1K  $\Omega$  resistor. See [Jumper Locations On Back of PCB \(Pg. 32\)](#).

### CONTROL CODES AND THEIR FUNCTIONS

The display module will accept plain ASCII characters and display them on the screen at the current cursor position. For example, if you send "Hello World", the display shows "Hello World". The display also supports a set of control characters that access other features of the display. Some of these commands require one or more parameters. In general, the parameters are "binary" characters, meaning that any value between 0 and 255 may be required.

The notation "\xxx" is used for "binary" data, where "xxx" is the decimal representation of the number. Use the codes \000 to \255 to include all possible values for a character. This notation is supported by our [cfTest](#) software. We recommend you try this utility by using the examples listed under [Description Of Control Functions \(Pg. 36\)](#).

You can select a line of the example text by highlighting it, copy, then paste into the cfTest edit box with a right-click "Paste". Be sure *not* to highlight the invisible carriage return at the end of the line.

Below is a summary of the control codes. Click on the links in the ASCII column to jump to an explanation of the code function.

ASCII	HEX	KEYSTROKES	CONTROL CODE FUNCTIONS
\000	0x00	–	<i>Not Accessible</i>
<a href="#">\001</a>	0x01	Control+A	Cursor Home
<a href="#">\002</a>	0x02	Control+B	Hide Display
<a href="#">\003</a>	0x03	Control+C	Show Display
<a href="#">\004</a>	0x04	Control+D	Hide Cursor
<a href="#">\005</a>	0x05	Control+E	Show Underline Cursor
<a href="#">\006</a>	0x06	Control+F	Show Blinking Block Cursor with Underscore
\007	0x07	–	<i>Not Accessible</i>
<a href="#">\008</a>	0x08	Control+H	Backspace (Destructive)
<a href="#">\009</a>	0x09	Control+I	Module Configuration



ASCII	HEX	KEYSTROKES	CONTROL CODE FUNCTIONS (Continued)
<a href="#">\010</a>	0x0A	Control +J or Control +Enter	Line Feed
<a href="#">\011</a>	0x0B	Control+K	Delete In Place
<a href="#">\012</a>	0x0C	Control+L	Form Feed (Clear Display)
<a href="#">\013</a>	0x0D	Control+M	Carriage Return
<a href="#">\014</a>	0x0E	Control+N	Backlight Control
<a href="#">\015</a>	0x0F	Control+O	Contrast Control
\016	0x10	–	<i>Not Accessible</i>
<a href="#">\017</a>	0x11	Control+Q	Set Cursor Position (Column and Row)
<a href="#">\018</a>	0x12	Control+R	Horizontal Bar Graph
<a href="#">\019</a>	0x13	Control+S	Scroll ON
<a href="#">\020</a>	0x14	Control+T	Scroll OFF
\021	0x15	–	<i>Not Accessible</i>
\022	0x16	–	<i>Not Accessible</i>
<a href="#">\023</a>	0x17	Control+W	Wrap ON
<a href="#">\024</a>	0x18	Control+X	Wrap OFF
<a href="#">\025</a>	0x19	Control+Y	Set Custom Character Bitmap
<a href="#">\026</a>	0x1A	Control Z	Reboot
<a href="#">\027</a>	0x1B	Escape	Escape Sequence Prefix
<a href="#">\028</a>	0x1C	Control+\	Large Block Number
\029	0x1D	–	<i>Not Accessible</i>
<a href="#">\030</a>	0x1E	Control+Equal	Send Data Directly to LCD Controller
<a href="#">\031</a>	0x1F	Control+Minus	Show Information Screen
\128 - \135			Custom Characters 0 through 7

## DESCRIPTION OF CONTROL FUNCTIONS

### Cursor Home (\001, 0x01, Control+A)

Moves cursor to the top left character position. No data is changed. Identical to Control+Q,0,0.

### Hide Display (\002, 0x02, Control+B)

Display is blanked; no data is changed.

### Show Display (\003, 0x03, Control+C)

Restores blanked display; nothing else is changed.



### Hide Cursor (\004, 0x04, Control+D)

Cursor is not shown; nothing else is changed.

### Show Underline Cursor (\005, 0x05, Control+E)

Sets cursor to nonblinking underscore.

### Show Blinking Block Cursor with Underscore (\006, 0x06, Control+F)

Sets cursor to blinking block underscore.

### Backspace (\008, 0x08, Control+H)

Moves the cursor back one space and erases the character in that space. Will wrap from the left-most column to the right-most column of the line above. Will wrap from the left-most column of the top row to the right-most column of the bottom row. Ignores wrap.

### Module Configuration (\009, 0x09, Control+I)

This command allows the current state of the display to be stored in the display's EEPROM, recalling of the EEPROM contents to the display, and controlling the boot behavior.

All features of the display are controlled: the characters displayed, the bitmaps of the user-definable characters, the backlight setting, the contrast setting, the cursor position, the cursor style, the wrap setting, the scroll setting, interface selection, baud rate, data normal / inverted, and boot state.

**Note**

Since writing and reading the EEPROM takes quite a bit time, it is possible to overflow the display's input buffer if data is continuously sent while the display is busy executing these commands. The display will still buffer data while these commands are being executed. However, the buffer is 64 bytes long and can be overflowed. You must take care to not overflow the input buffer while the EEPROM commands are executing.

MODULE CONFIGURATION COMMANDS	
<b>Display Duration</b>	
\009\000	
\000	Displays permanently.
\001	Displays until input.
\002	Displays for ~5 seconds, then is blank.
<b>Screen Selection</b>	
\009\001	
\000	CrystalFontz display.
\001	User display (custom boot screen).

**Note:**

When changing any communication settings, the selection takes place immediately. Have proper cables ready to use *before* changing interfaces.

You will need to reconnect at the new baud rate if using *Baud Selection (RS232 Only)* or reconnect for the new address if changing *Set Slave Address (I<sup>2</sup>C Only)*.

1. Connect at the current interface and/or baud rate.
2. Send command to change to new interface and/or baud rate. If changing interface, refer to table [JUMPERS THAT CAN BE CHANGED \(Pg. 33\)](#) to ensure jumpers are set appropriately.
3. Reconnect at current interface and/or baud rate.



MODULE CONFIGURATION COMMANDS (Continued)	
<b>Interface Selection</b>	
\009\002	
\000	USB
\001	“full swing” RS232 serial interface over DB9
\002	SPI
\003	I <sup>2</sup> C
\004	LL (logic level serial)
\005	LLi (logic level serial, inverted)

*Example: Change Interface*

1. Connect using the *current* interface (USB by default for CFA\*\*\*-\*\*\*-KU, RS232 by default for CFA\*\*\*-\*\*\*-KS etc).
2. Send command \009\002\002 (e.g., SPI interface) using cfTest or any other communication software.
3. Disconnect the current interface.
4. Ensure jumpers JP3 and JP4 are closed and jumpers JP5 and JP6 are open. (See [Location and Description of Jumpers To Change Interface Type \(Pg. 32\).](#))
5. Connect using the new interface.

<b>Baud Selection (RS232 Only)</b>	
\009\003	
\000	2400 bps
\001	4800 bps
\002	9600 bps
\003	19200 bps
\004	115200 bps

*Example: Change Baud Rate*

Baud Selection is only applicable to RS232.

1. Ensure jumpers JP3 and JP4 are open and jumpers JP5 and JP6 are closed. See [Location and Description of Jumpers To Change Interface Type \(Pg. 32\).](#)
2. Connect using the RS232 interface.
3. Send Command \009\003\002 (9600 bps) using cfTest or any other communication software.
4. Reconnect at the new baud rate.

<b>Set Slave Address (I<sup>2</sup>C Only)</b>	
\009\004	
Data[1]	New Address

<b>Save Settings</b>	
\009\005	

<b>Recall Settings</b>	
\009\006	

### Line Feed (\010, 0x0A, Control+J or Control+Enter)

Moves the cursor down one row. If SCROLL is on and the cursor is at the bottom row, the display will scroll up one row and the bottom row will be cleared.

#### Note

If SCROLL is set, the cursor is placed on the bottom line, several Line Feed characters are sent (forcing the display to scroll), and these Line Feeds characters are immediately followed by a burst of more than 64 additional characters—it is possible to overflow the display’s input buffer. Don’t do this. Contrary to design standards for Internet server software from our favorite software monopoly, the display will not start executing the input buffer data as if it were code. The display will simply overwrite the oldest data in the input buffer with the most recently received data.



### Delete In Place (\011, 0x0B, Control+K)

Deletes the character at the current cursor position. Cursor is not moved.

### Form Feed (\012, 0x0C, Control+L)

Clears the display and returns cursor to Home position (upper left). All data is erased.

### Carriage Return (\013, 0x0D, Control+M)

Moves cursor to the left-most column of the current row.

### Backlight Control (\014, 0x0E, Control+N)

Send "Control+N", followed by a byte from 0-100 for the backlight brightness. 0=OFF, 100=ON, intermediate values will vary the brightness.

Examples:

```
\014\000  
\014\050  
\014\100
```

### Contrast Control (\015, 0x0F, Control+O)

Send "Control+O", followed by a byte from 0-100 for the contrast setting of the displayed characters.

0 = very light      40 = typical      100 = very dark

Examples:

```
\015\050  
\015\060  
\015\070
```

### Set Cursor Position (Column and Row) (\017, 0x11, Control+Q)

Send "Control+Q" followed by one byte for the column (0-15), and a second byte for the row (0-3). The upper-left position is 0,0. The lower-right position is 15,1.

For example, to move the cursor to column 11 of the second line:

```
\017\010\001
```

### Horizontal Bar Graph (\018, 0x18, Control+R)

Send "Control+R" followed by the following bytes:

```
graph_index  
style  
start_column  
end_column  
length  
row
```



**graph\_index** determines which custom characters are used.

<b>graph_index</b>	<b>CUSTOM CHARACTERS USED</b>
\000	0,1
\001	2,3
\002	4,5
\003	6,7

**style** is the bit pattern to use in drawing the graph.

<b>style</b>	<b>PATTERN</b>	<b>DESCRIPTION</b>
\255	(11111111b)	thick bar
\000	(00000000b)	not visible (all pixels are off)
\085	(01010101b)	striped bar
\060	(00111100b)	medium width bar, centered
\015	(00001111b)	medium width bar, low in the row
\240	(11110000b)	medium width bar, high in the row

Any value is valid between \000 and \255. The MSB (Most Significant Bit) is at the top of the row, the LSB (Least Significant Bit) is at the bottom of the row.

**start\_column** and **end\_column** are the character X coordinates of the graph area. Each must be between \000 and \015. **start\_column** must be less than or equal to **end\_column**.

**length** is the length in pixels of the graph. Positive values will graph from the left edge of **start\_column**, negative values will graph from the right edge of **end\_column**. There are six pixels per character, so the maximum value of **length** is  $16 \times 6 = \backslash096$ .

**row** is the character Y coordinate. \000-\001 is valid.

Examples:

```
\018\000\255\000\014\010\001
\018\000\015\000\014\236\001
```

Note

The entire graph area is completely rewritten by each graph command, so there is no need to clear the area between successive updates of the same graph. If a length of \000 is written, the entire graph area is cleared to spaces. Negative values can be calculated as 256 - value. For instance, if you want a graph to extend 20 pixels towards the left, from the right most column of the graph area, send 236 (256 - 20 = 236). No additional graph "setup" command is needed.





Note

The graphs use some of the custom characters and may corrupt the display contents if there are user-defined custom characters or large numbers shown.

### Scroll ON (\019, 0x13, Control+S)

Turns scroll feature on. Then a Line Feed (Control+J) command from the bottom row will scroll the display up by one row, independent of Wrap. If Wrap is also on (Control+W), a wrap occurring on the bottom row will cause the display to scroll up one row. Scroll is on by default.

### Scroll OFF (\020, Control+T)

Turns scroll feature off. Then a Line Feed (Control+J) command from the bottom row will move the cursor to the top row of the same column, independent of wrap (Control+W for Wrap ON, Control+X for Wrap OFF). If wrap is on, a wrap occurring on the bottom row will also wrap vertically to the top row. Scroll is on by default at power-up.

### Wrap ON (\023, 0x17, Control+W)

Turns wrap feature on. When wrap is on, a printable character received when the cursor is at the right-most column will cause the cursor to move down one row to the left-most column. If the cursor is already at the right-most column of the bottom row, it will wrap to the top row if Scroll is off, or the display will scroll up one row if Scroll is on.

### Wrap OFF (\024, 0x18, Control+X)

Turns wrap feature off. When wrap is off, a printable character received when the cursor is at the right-most column will cause the cursor to disappear as it will be off the right edge of the screen. Any subsequent characters will be ignored until some other command moves the cursor back onto the display. This function is independent of Scroll.

### Set Custom Character Bitmap (\025, 0x19, Control+Y)

The custom characters are mapped at \128 through \135 corresponding to character 0 to character 7.

Send "Control+Y" followed by the following bytes:

***character***  
***data0***  
***data1***  
***data2***  
***data3***  
***data4***  
***data5***  
***data6***  
***data7***



**character** determines which of the eight custom characters is modified. 0-7 is valid. The custom characters are displayed by sending \128 to \135:

<i>character</i>	CUSTOM CHARACTER MODIFIED
\128	0
\129	1
\130	2
\131	3
\132	4
\133	5
\134	6
\135	7

**data0-data7** are the bitmap information for this character. Any value is valid between 0 and 63. The MSB is at the left of the character cell of the row and the LSB is at the right of the character cell. data0 is at the top of the cell, data7 is at the bottom of the cell.

Note

The large digits use all of the custom characters, so if you modify the custom characters when large digits are displayed, the display will probably become corrupted. The bar graphs also use some of the custom characters.

Examples:

```
\012\001\128\129\130\131\017\000\001\132\133\134\135
\025\000\000\000\001\003\000\031\031\031
\025\001\028\054\032\001\003\051\051\051
\025\002\014\027\049\032\032\047\032\047
\025\003\000\000\032\048\000\062\000\062
\025\004\031\031\031\000\003\001\000\000
\025\005\051\051\051\003\001\032\054\028
\025\006\047\032\047\032\032\049\027\014
\025\007\062\000\062\000\048\032\000\000
```

**Reboot (\026, 0x1A, Control+Z)**

The firmware is stable and robust. It is unlikely that you will ever need a “reboot” command. If the firmware did crash, the command processor would likely be inoperable and unable to detect the reboot command. However, you may have certain situations where it is nice to have a command that will return the display to a known state. For instance, if the baud rate on the host is set to an incorrect speed, the data is interpreted as meaningless garbage which the display firmware tries to interpret. Some data may set the contrast to an unusable value; some data may program the LCD controller to an indeterminate state. Or perhaps you always want the display to wake up in a given state when your program starts, without going through all the commands that affect the way the display interprets commands (such as the state of Scroll or Wrap, for instance).

Send one “Control+Z” followed by another “Control+Z” to reboot the display. If you are not sure of the display state, it may be necessary to send up to 9 characters to satisfy the parameters of some previous command. For example, if the Set Custom Character Bitmap command (See [Set Custom Character Bitmap \(\025, 0x19, Control+Y\) \(Pg. 41\)](#)) has just



been received by the display when an application crashes, the display will interpret the next 9 bytes as the parameters to the command, then wait for more commands. If you are not sure what the status of the display is, send 9 blanks (\032) followed by two "Control+Z"s (\026).

For RS232 serial (CFA632-\*\*\*-KS): If the display in your system is powered by the serial port's RTS and DTR lines, the display can be rebooted by dropping those lines momentarily (for example, 500 mS) and then bringing them high again.

### Escape Sequence Prefix (\027, 0x1B, Escape)

Four escape sequences are supported. These correspond to the escape sequences that are sent for the four arrows keys in HyperTerminal with an ANSI terminal selected (and also our [cfTest](#) test and development software). These sequences move the cursor only and do not wrap.

ESCAPE SEQUENCE	ARROW KEY
ESC [ A (equivalent to \027\091\065)	UP arrow
ESC [ B (equivalent to \027\091\066)	DOWN arrow
ESC [ C (equivalent to \027\091\067)	RIGHT arrow
ESC [ D (equivalent to \027\091\068)	LEFT arrow

### Escape Sequence Prefix (\027, 0x1B, Escape)

Four escape sequences are supported. These correspond to the escape sequences that are sent for the four arrows keys in HyperTerminal with an ANSI terminal selected (and also our [cfTest](#) test and development software). These sequences move the cursor only and do not wrap.

ESCAPE SEQUENCE	ARROW KEY
ESC [ A (equivalent to \027\091\065)	UP arrow
ESC [ B (equivalent to \027\091\066)	DOWN arrow
ESC [ C (equivalent to \027\091\067)	RIGHT arrow
ESC [ D (equivalent to \027\091\068)	LEFT arrow

### Large Block Number (\028, Control Backslash)

Send "Control+Backslash" followed by the following bytes:

**style**  
**column**  
**number**

**style** determines if a large number (3x4 or a 4x4) is displayed:

style	FUNCTION
\000	3x4 large number
\001	4x4 large number
\002	invalid



**column** is the starting column of the number.

\000-\017 are valid for a style of \000 (3x4)  
\000-\016 are valid for a style of \001 (4x4)

**number** is the number to display. \048 to \057 ('0' to '9') are valid.

Note  
The large numbers use all the custom characters. There will be some corruption if they are used at the same time as graphs or user defined custom characters. No large number initialization command is needed.

Example:

```
\004\012\028\000\0010\028\000\0051\028\000\0092\028\000\0133\028\000\0174
\004\012\028\000\0005\028\000\0046\028\000\0087\028\000\0128\028\000\0169

\004\012\028\001\0000\028\001\0051\028\001\0102\028\001\0153
\004\012\028\001\0006\028\001\0057\028\001\0108\028\001\0159
```

### Send Data Directly to the LCD Controller (\030, 0x1E, Control+Equal)

Send “Control+Equal” followed by the following bytes:

**location**  
**data**

**location** is the destination register on the LCD controller:

<b>location</b>	<b>REGISTER</b>
\000	Control Register, (RS=0, RE=0)
\001	Data Memory, (RS=1, RE=x)

**data** is the data to write to the controller.

Note  
This command executes a low level write directly to the controller. Use this command at your own risk. “Control+Z” followed by another “Control+Z” will reboot the display and recover from most mistakes.  
  
This command can disable or damage your display. Use this command at your own risk.

Example:

```
\030\002\031\030\002\130
```

### Show Information Screen (\031, 0x1F, Control+Minus)

This function will show the baud rate for CFA632-\*\*\*-KL and CFA632-\*\*\*-KS. This function will show the interface mode for CFA632-\*\*\*-KC, CFA632-\*\*\*-KP, and CFA632-\*\*\*-KU.



# CHARACTER GENERATOR ROM (CGROM)

upper 4 bits lower 4 bits	0 <sub>d</sub> 0000.	16 <sub>d</sub> 0001.	32 <sub>d</sub> 0010.	48 <sub>d</sub> 0011.	64 <sub>d</sub> 0100.	80 <sub>d</sub> 0101.	96 <sub>d</sub> 0110.	112 <sub>d</sub> 0111.	128 <sub>d</sub> 1000.	144 <sub>d</sub> 1001.	160 <sub>d</sub> 1010.	176 <sub>d</sub> 1011.	192 <sub>d</sub> 1100.	208 <sub>d</sub> 1101.	224 <sub>d</sub> 1110.	240 <sub>d</sub> 1111.
0 <sub>d</sub> 0000.	CGRAM [0]															
1 <sub>d</sub> 0001.	CGRAM [1]															
2 <sub>d</sub> 0010.	CGRAM [2]															
3 <sub>d</sub> 0011.	CGRAM [3]															
4 <sub>d</sub> 0100.	CGRAM [4]															
5 <sub>d</sub> 0101.	CGRAM [5]															
6 <sub>d</sub> 0110.	CGRAM [6]															
7 <sub>d</sub> 0111.	CGRAM [7]															
8 <sub>d</sub> 1000.	CGRAM [0]															
9 <sub>d</sub> 1001.	CGRAM [1]															
10 <sub>d</sub> 1010.	CGRAM [2]															
11 <sub>d</sub> 1011.	CGRAM [3]															
12 <sub>d</sub> 1100.	CGRAM [4]															
13 <sub>d</sub> 1101.	CGRAM [5]															
14 <sub>d</sub> 1110.	CGRAM [6]															
15 <sub>d</sub> 1111.	CGRAM [7]															

Figure 18. Character Generator ROM (CGROM)



## HOW TO USE CGROM

The CGROM defines which characters are shown by the display for a given code received through the interface. The display module firmware has an enhanced CGROM that includes many useful special characters (including numeric superscripts, icons, mathematical symbols, some fractions, a great variety of arrows, and many currency symbols).

Most of the characters can be accessed by sending the appropriate ASCII code to the display. For instance, the letter "A" can be shown by sending an "A" (which is the same as a "decimal 65", a "hex 0x41", or a "\065").

Some characters do not have an obvious match. For instance, the code to display a superscript "9" is "decimal 137", "hex 0x89", or "\137". The relationship between the codes and the characters are shown on in the [Character Generator ROM \(CGROM\) \(Pg. 45\)](#).

To find the code for a given character, add the two numbers that are shown in bold for its row and column. For example, the superscript "9" is in the column labeled "128d" and in the row labeled "9d". So you would add 128 + 9 to get 137. When you send a byte with the value of 137 to the display, then a superscript "9" will be shown at the current cursor position.

In the CFA632 v1.0, the CGROM table had several columns that did not have any characters assigned to the codes. The commands to control the display were mapped to some of those unused codes. These codes are shown in red in the table. Specifically, the first 32 codes (0 to 31) are reserved for the display's special functions (cursor positioning, contrast control, bar graphs), and the codes from 128 to 135 are used to access the custom characters.

To access the characters shown in red, it is necessary to send some data directly to the LCD controller. [Send Data Directly to the LCD Controller \(\030, 0x1E, Control+Equal\) \(Pg. 44\)](#) allows any character in the CGROM to be displayed.

For example, if you want to display an arrow that points to the upper left, look at the table and note that it is in column "16d", and in row "6d", so its code is 22 (16 + 6 = 22). Use the following sequence to display the arrow that points to the upper left:

```
\030\001\022
```

This sequence of three bytes must be used to display any of the characters shown in red in the table. It can also be used to access any character in the table.



## DISPLAY MODULE RELIABILITY AND LONGEVITY

---

*Note:* We work to continuously improve our products, including backlights that are brighter and last longer. Slight color variations from module to module and batch to batch are normal.

### DISPLAY MODULE RELIABILITY

ITEM	SPECIFICATION
Display With Yellow-Green Backlight	50,000 to 100,000 hours
<i>Under operating and storage temperature specification limitations, humidity non-condensing RH up to 65%, and no exposure to direct sunlight. Value listed above are approximate and represent typical lifetime.</i>	

### DISPLAY MODULE LONGEVITY (EOL / REPLACEMENT POLICY)

CrystalFontz is committed to making all of our display modules available for as long as possible. Occasionally, a supplier discontinues a component, or a process used to make the module becomes obsolete, or the process moves to a more modern manufacturing line. In order to continue making the module, we will do our best to find an acceptable replacement part or process which will make the “replacement” fit, form, and function compatible with its predecessor.

We recognize that discontinuing a module may cause problems for some customers. However, rapidly changing technologies, component availability, or low customer order levels may force us to discontinue (“End of Life”, EOL) a module. For example, we must occasionally discontinue a module when a supplier discontinues a component or a manufacturing process becomes obsolete. When we discontinue a module, we will do our best to find an acceptable replacement module with the same fit, form, and function.

In most situations, you will not notice a difference when comparing a “fit, form, and function” replacement module to the discontinued module it replaces. However, sometimes a change in component or process for the replacement module results in a slight variation, perhaps an improvement, over the previous design.

Although the replacement module is still within the stated Data Sheet specifications and tolerances of the discontinued module, changes may require modification to your circuit and/or firmware. Possible changes include:

- **Backlight LEDs.** Brightness may be affected (perhaps the new LEDs have better efficiency) or the current they draw may change (new LEDs may have a different VF).
- **Controller.** A new controller may require minor changes in your code.
- **Component tolerances.** Module components have manufacturing tolerances. In extreme cases, the tolerance stack can change the visual or operating characteristics.

Please understand that we avoid changing a module whenever possible; we only discontinue a module if we have no other option. We publish Part Change Notices (PCN) as soon as possible.

## CARE AND HANDLING PRECAUTIONS

---

For optimum operation of the display module and to prolong its life, please follow the precautions described below. Excessive voltage will shorten the life of the module. You must drive the display within the specified voltage limit. See [Absolute Maximum Ratings \(Pg. 16\)](#).



## HANDLING CAUTION FOR DISPLAY MODULES SHIPPED IN TRAYS

If you receive modules packed in trays, handle trays carefully by supporting the entire tray. Trays were made to immobilize the modules inside their packing carton. Trays are not designed to be rigid. Do not carry trays by their edges; trays and modules may be damaged.

## ESD (ELECTRO-STATIC DISCHARGE) SPECIFICATIONS

The circuitry is industry standard CMOS logic and is susceptible to ESD damage. Please use industry standard anti static precautions as you would for any other static sensitive devices such as expansion cards, motherboards, or integrated circuits. Ground your body, work surfaces, and equipment.

## DESIGN AND MOUNTING

- The RockWorks RW1067 or compatible controller maintains its internal operating modes until something happens to change it. Excessive external noise can change these internal modes. In your packaging and system design, suppress or prevent the noise from influencing the controller. Also, refresh the operating modes periodically to prevent the effects of unanticipated noise.
- The exposed surface of the LCD “glass” is actually a polarizer laminated on top of the glass. To protect the polarizer from damage, the display module ships with a protective film over the polarizer. Please peel off the protective film slowly. Peeling off the protective film abruptly may generate static electricity.
- The polarizer is made out of soft plastic and is easily scratched or damaged. When handling the module, avoid touching the polarizer. Finger oils are difficult to remove.
- To protect the soft plastic polarizer from damage, place a transparent plate (for example, polycarbonate or glass) in front of the display module, leaving a small gap between the plate and the display surface. We recommend Lexan® which is readily available and works well.
- Do not disassemble or modify the module.
- Do not modify the eight tabs of the metal bezel or make connections to them.
- Solder only to the I/O terminals. Use care when removing solder so you do not damage the PCB. Use care when removing solder so you do not damage the PCB. Use care to keep the exposed terminals clean. Contamination, including fingerprints, may make soldering difficult and the reliability of the soldered connection poor.
- Do not reverse polarity to the power supply connections. Reversing polarity will immediately ruin the module.

## AVOID SHOCK, IMPACT, TORQUE, OR TENSION

- Do not expose the module to strong mechanical shock, impact, torque, or tension.
- Do not drop, toss, bend, or twist the module.
- Do not place weight or pressure on the module.

## CAUTION

All electronics may contain harmful substances. Avoid contamination by using care to avoid damage during handling. If any residues, gases, powders, liquids, or broken fragments come in contact with your skin, eyes, mouth, or lungs, immediately contact your local poison control or emergency medical center.

## HOW TO CLEAN

The polarizer will eventually become hazy if you do not take great care when cleaning it. Follow these cleaning steps:

1. Turn display off.





2. Use the removable protective film to remove smudges (for example, fingerprints) and any foreign matter. If you no longer have the protective film, use standard transparent office tape (for example, Scotch® brand “Crystal Clear Tape”).
3. If the polarizer is dusty, you may carefully blow it off with clean, dry, oil-free compressed air.
4. If you must clean with a liquid, never use glass cleaners, as they may contain ammonia or alcohol that will damage the polarizer over time. Never apply liquids directly on the polarizer. Long contact with moisture may permanently spot or stain the polarizer. Use filtered water to slightly moisten a clean lint-free microfiber cloth designed for cleaning optics. (For example, use a cloth sold for cleaning plastic eyeglasses.) Do not use Q-tips.
5. The plastic is easily scratched or damaged. Use a light touch as you clean the polarizer. Wipe gently.
6. Use a dry microfiber cloth to remove any trace of moisture before turning on the module.
7. Gently wash the microfiber cloths in warm, soapy water and air dry before reuse.

## OPERATION

- Your circuit should be designed to protect the module from ESD and power supply transients.
- Observe the operating temperature limitations: a minimum of  $-20^{\circ}\text{C}$  to a maximum of  $+70^{\circ}\text{C}$  non-condensing with minimal fluctuation. Operation outside of these limits may shorten life and/or harm display. Changes in temperature can result in changes in contrast.
  - At lower temperatures of this range, response time is delayed.
  - At higher temperatures of this range, display becomes dark. (You may need to adjust the contrast.)
- Operate away from dust, moisture, and direct sunlight.

## STORAGE AND RECYCLING

- Store in an ESD-approved container away from dust, moisture, and direct sunlight, fluorescent lamps, or any strong ultraviolet radiation.
- Observe the storage temperature limitations: a minimum of  $-30^{\circ}\text{C}$  minimum to  $+80^{\circ}\text{C}$  non-condensing maximum with minimal fluctuations. Rapid temperature changes can cause moisture to form, resulting in permanent damage.
- Do not allow weight to be placed on the modules while they are in storage.
- To discard, please recycle your modules at an approved facility.



# APPENDIX A: FREE DEMONSTRATION AND DRIVER SOFTWARE

---

## DEMONSTRATION SOFTWARE

Demonstration software is available for free download under the *Related* tab on the website page for each CFA632 part number. Or click on the links in the software descriptions below. No registration is required for download.

### cfTest

[cfTest](#) for Windows is testing and configuration software that works on all Crystalfontz Intelligent LCD modules. This software allows you to experiment with the command set for all Crystalfontz Intelligent LCDs.

Streaming communication based modules (CFA632, CFA634) and packet communication based modules (CFA533, CFA631, CFA633, CFA635, CFA735, CFA835) are supported. Windows (XP, Vista, 7, 8), Linux, and Mac (OSX) versions are available.

### CrystalControl2 (CC2)

For use with USB and serial interfaces. [CrystalControl2](#) for Windows displays a great variety of varying information to a Crystalfontz Intelligent LCD Modules in a configurable way. We provide a [User Manual](#) and support through our [forum](#).

### Linux\_CLI\_Examples

[Linux\\_CLI\\_Examples](#) is a Linux compatible command-line demonstration program with C source code. 8K.

### BasicStamp2

For CFA632-xxx-KS The [BasicStamp2](#) is a simple program that demonstrates communications from a Parallax Basic Stamp.

### 632/634 Boot Screen Beta Version

For CFA632-xxx-KS and CFA632-xxx-KU [632/634 Boot Screen Beta Version](#) allows you to change the boot screen and boot behavior, set custom characters, and make logos using multiple custom characters. For use only with display modules hardware v.2.4 and below.

## DRIVERS

### Linux Driver

See <http://lcdproc.omnipotent.net> for Linux LCD drivers. LCDproc is an open source project that supports many of the Crystalfontz displays.



## USB LCD Driver

For CFA632-xxx-KU, the [USB LCD Driver](#) download has self-extracting Microsoft signed drivers for versions of Windows from XP to current. *Note:* If you do Windows updates on your PC, Windows USB drivers are automatically included.



## APPENDIX B: QUALITY ASSURANCE STANDARDS

### INSPECTION CONDITIONS

- Environment
  - Temperature:  $25\pm 5^{\circ}\text{C}$
  - Humidity: 30~85% RH
- For visual inspection of active display area
  - Source lighting: two 20 Watt or one 40 Watt fluorescent light
  - Display adjusted for best contrast
  - Viewing distance:  $30\pm 5$  cm (about 12 inches)
  - Viewing angle: inspect at  $45^{\circ}$  angle of vertical line right and left, top and bottom

### COLOR DEFINITIONS

We try to describe the appearance of our modules as accurately as possible. For the photos, we adjust for optimal appearance. Actual display appearance may vary due to (1) different operating conditions, (2) small variations of component tolerances, (3) inaccuracies of our camera, (4) color interpretation of the photos on your monitor, and/or (5) personal differences in the perception of color.

### DEFINITION OF ACTIVE AREA AND VIEWING AREA

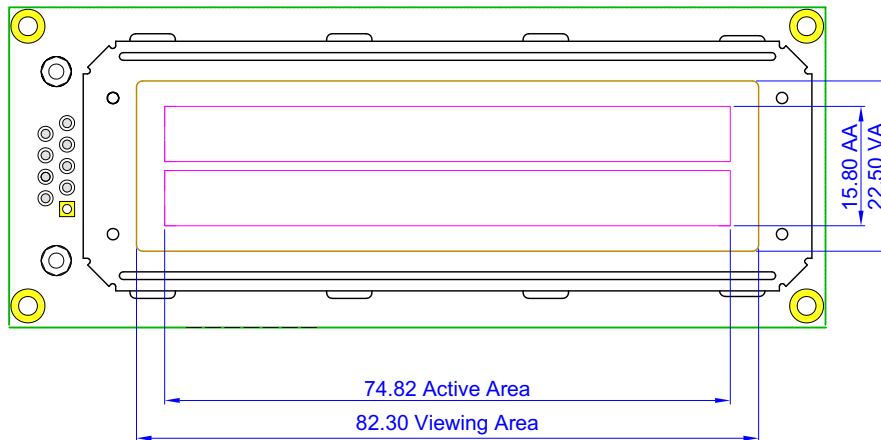

### DEFECTS CLASSIFICATION

Defects are defined as:

- Major Defect: results in failure or substantially reduces usability of unit for its intended purpose
- Minor Defect: deviates from standards but is not likely to reduce usability for its intended purpose

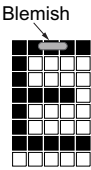
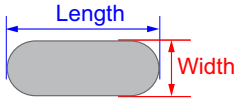
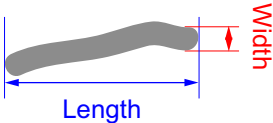

## ACCEPTANCE STANDARDS

#	DEFECT TYPE	ACCEPTANCE STANDARDS CRITERIA			MAJOR/ MINOR	
1	Electrical defects	1. No display, display malfunctions, or shorted segments. 2. Current consumption exceeds specifications.			Major	
2	Viewing area defect	Viewing area does not meet specifications. (See <a href="#">Inspection Conditions (Pg. 52)</a> ).			Major	
3	Contrast adjustment defect	Contrast adjustment fails or malfunctions.			Major	
4	Blemishes or foreign matter on display segments		<i>Defect Size (mm)</i>	<i>Acceptable Qty</i>	Minor	
			$\leq 0.3$	3		
			$\leq 2$ defects within 10 mm of each other			
5	Other blemishes or foreign matter outside of display segments	Defect size = $(A + B)/2$ 	<i>Defect Size (mm)</i>	<i>Acceptable Qty</i>	Minor	
			$\leq 0.15$	Ignore		
			0.15 to 0.20	3		
			0.20 to 0.25	2		
			0.25 to 0.30	1		
6	Dark lines or scratches in display area		<i>Defect Width (mm)</i>	<i>Defect Length (mm)</i>	<i>Acceptable Qty</i>	Minor
			$\leq 0.03$	$\leq 3.0$	3	
			0.03 to 0.05	$\leq 2.0$	2	
			0.05 to 0.08	$\leq 2.0$	1	
			0.08 to 0.10	$\leq 3.0$	0	
			$\geq 0.10$	$> 3.0$	0	
7	Bubbles between polarizer film and glass		<i>Defect Size (mm)</i>	<i>Acceptable Qty</i>	Minor	
			$\leq 0.20$	Ignore		
			0.20 to 0.40	3		
			0.40 to 0.60	2		
			$\geq 0.60$	0		



#	DEFECT TYPE	ACCEPTANCE STANDARDS CRITERIA (Continued)	MAJOR / MINOR							
8	Display pattern defect		Minor							
		<table border="1"> <tr> <th>Dot Size (mm)</th> <th>Acceptable Qty</th> </tr> <tr> <td><math>((A+B)/2) \leq 0.2</math></td> <td rowspan="5"> <math>\leq 3</math> total defects  <math>\leq 2</math> pinholes per digit                 </td> </tr> <tr> <td><math>C &gt; 0</math></td> </tr> <tr> <td><math>((D+E)/2) \leq 0.25</math></td> </tr> <tr> <td><math>((F+G)/2) \leq 0.25</math></td> </tr> </table>		Dot Size (mm)	Acceptable Qty	$((A+B)/2) \leq 0.2$	$\leq 3$ total defects $\leq 2$ pinholes per digit	$C > 0$	$((D+E)/2) \leq 0.25$	$((F+G)/2) \leq 0.25$
		Dot Size (mm)		Acceptable Qty						
		$((A+B)/2) \leq 0.2$		$\leq 3$ total defects $\leq 2$ pinholes per digit						
		$C > 0$								
$((D+E)/2) \leq 0.25$										
$((F+G)/2) \leq 0.25$										
9	Backlight defects	<ol style="list-style-type: none"> <li>1. Light fails or flickers.*</li> <li>2. Color and luminance do not correspond to specifications.*</li> <li>3. Exceeds standards for display's blemishes or foreign matter (<a href="#">see test 5, Pg. 53</a>), and dark lines or scratches (<a href="#">see test 6, Pg. 53</a>).</li> </ol> <p><i>*Minor if display functions correctly. Major if the display fails.</i></p>	Minor							
10	COB defects	<ol style="list-style-type: none"> <li>1. Pinholes <math>&gt; 0.2</math> mm.</li> <li>2. Seal surface has pinholes through to the IC.</li> <li>3. More than 3 locations of sealant beyond 2 mm of the sealed areas.</li> </ol>	Minor							
11	PCB defects	<ol style="list-style-type: none"> <li>1. Oxidation or contamination on connectors.*</li> <li>2. Wrong parts, missing parts, or parts not in specification.*</li> <li>3. Jumpers set incorrectly.</li> <li>4. Solder (if any) on bezel, LED pad, zebra pad, or screw hole pad is not smooth.</li> </ol> <p><i>*Minor if display functions correctly. Major if the display fails.</i></p>	Minor							
12	Soldering defects	<ol style="list-style-type: none"> <li>1. Unmelted solder paste.</li> <li>2. Cold solder joints, missing solder connections, or oxidation.*</li> <li>3. Solder bridges causing short circuits.*</li> <li>4. Solder balls.</li> </ol> <p><i>*Minor if display functions correctly. Major if the display fails.</i></p>	Minor							